



UNO elektronika d.o.o.
elektronske in elektromehanske komponente

Dolenja vas 1b
6224 Senožeče
tel: 05 76-56-140
fax: 05 76-56-141
gsm: 041 673 619
mail: uno.elektronika@siol.net
www.unoelektronika.si

KATALOG

2012/2013

KAZALO STRANI

naziv	stran
Stikala, tipke 	A-1 — A-7
Konektorji, vtikači, vtičnice 	B-1 — B-14
Napajalniki, polnilci, pretvorniki 	C-1 — C-8
Merilni instrumenti 	D-1 — D-3
Žarnice, LED diode 	E-1 — E-4
Avto konektorji 	F-1 — F-2
Krokodili 	G-1
Varovalke 	G-2
Kabel čevlji 	G-3
Orodja 	G-4 — G-5
Izolir trakovi, bužirke, objemke z žebličkom 	G-6 — G-7
Spajkala, konice, cin, pumpice 	H-1 — H-3
Ventilatorji 	H-4 — H-5
Baterije Ni-Cd, Ni-Mh, Pb, litij 	H-6 — H-11
Avdio / video / PC kabli 	I-1 — I-4
Napajalni kabli 	I-5
Antenski kabli / RG kabli 	I-6 — I-7
Mikrofonski kabli 	I-8
UTP in telefonski kabli 	I-9
Mikrovtikači 	I-10
Vezice in vezni elementi 	L-1 — L-4
Antenski material 	M-1 — M-6
Releji 	N-1 — N-6
Senzorji, diode, potenciometri 	N-7 — N-11
Baterijske svetilke 	O1



Stranka UNO ELEKTRONIKA d.o.o., Dolenja vas 1b, 6224 Senožeče, je vpisana v evidenco proizvajalcev in pridobiteljev električne in elektronske opreme pri Agenciji RS za okolje pod številko 134. Stranka zagotavlja ponovno uporabo, recikliranje in predelavo odpadne opreme!

Stranka UNO ELEKTRONIKA d.o.o., Dolenja vas 1b, 6224 Senožeče, je vpisana v evidenco dobaviteljev baterij in akumulatorjev pri Agenciji RS za okolje pod številko 314.

Katalog je informativne narave. Napake v oblikovanju in tisku so možne, zato si pridržujemo pravico do sprememb.
Slike, načrti in besedila so avtorsko zaščiteni!

UNO elektronika d.o.o.
Dolenja vas 1b
6224 Senožeče
tel. 05 76-56-140
fax. 05 76-56-141
mail: uno.elektronika@siol.net
www.unoelektronika.si
trr.: 10100-0000001062
id. št. za DDV: SI53606426

TIPKA MINI



Tipka mini fi 6mm
1A 230V
kontakti normalno odprti
ohišje: pvc
kontakti: na spajkanje

koda	pak.	barva
C4/6500	10	rdeča
C4/6502	10	črna
C4/6510	5	rdeča

kontakti zaprti!

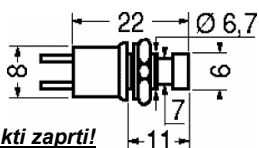

TIPKA



Tipka fi 19mm s kromiranim obročem
0,7A 250V
kontakti normalno odprti
ohišje: pvc
kontakti: na spajkanje

koda	pak.	barva
C4/6530	10	rdeča
C4/6532	10	črna

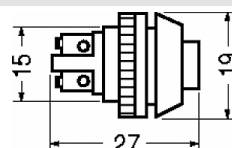

TIPKA SUBMINI ČRNA



Tipka submini fi 5mm
0,5A 125V
kontakti normalno odprti
kontakti: na spajkanje

koda	pak.	barva
C4/6499	10	črna

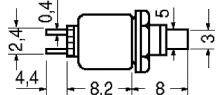

TIPKA



Tipka 9x9mm
1A 125V
kontakti normalno odprti
ohišje: makrolon
kontakti: na spajkanje

koda	pak.	barva
C4/6537B	10	črna
C4/6537BR	10	rdeča

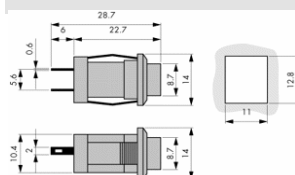

TIPKA MINI



Tipka mini fi 8mm
1,5A 250V
kontakti normalno odprti
ohišje: pvc
kontakti: na spajkanje

koda	pak.	barva
C4/6514	10	rdeča
C4/6515	10	črna

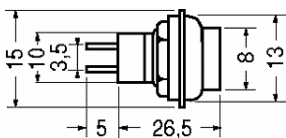

TIPKA MINI 3 POZICIJE



Tipka mini enopolna
3A 250V, 6A 125V
enopolna
kontakti: na spajkanje

koda	pakiranje	pozicije
C4/6588	10	nestabilna - stabilna - nestabilna

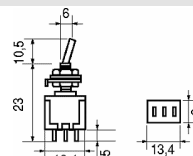

TIPKA



Tipka fi 12mm
1,5A 250V
kontakti normalno odprti
ohišje: pvc
kontakti: na spajkanje

koda	pak.	barva
C4/6519	10	črna

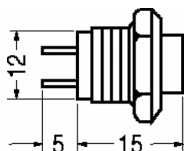

TIPKA



Tipka 22x30mm
16A 250V
dvopolna
kontakti normalno odprti
ohišje: ABS
kontakti: faston 6,3mm

koda	pakiranje
C4/7148-6	1

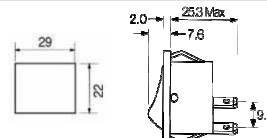

TIPKA



Tipka 11x30mm
16A 250V
enopolna
kontakti normalno odprti
ohišje: ABS
kontakti: faston 6,3mm

koda	pakiranje
C4/6908	1

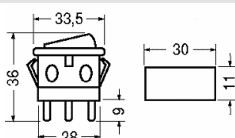

TIPKA 3 POZICIJE



Tipka 3 pozicije dvopolna
16A 250V
dvopolna
ohišje: ABS
kontakti: faston 6,3mm

koda	pak.	pozicije
C4/7148-7	5	nestab.- 0 -nestab.

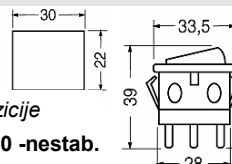

PREKLOPNIK SUBMINI ENOPOLNI



Preklopnik submini
1,5A 250V, 3A 125V
enopolni
kontakti: na spajkanje

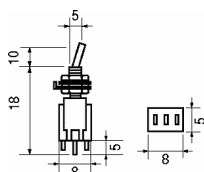

koda pak. pozicije
C4/6590 10 1-1

STIKALO ENOPOLNO



Stikalo enopolno prof.
10A 250V, 15A 125V
enopolno
kontakti: faston 6,3mm

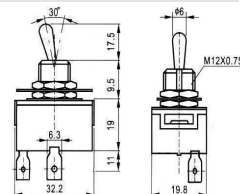

koda pakiranje pozicije
C4/6630 10 0-1

PREKLOPNIK SUBMINI DVOPOLNI



Preklopnik submini
1,5A 250V, 3A 125V
dvopolni
kontakti: na spajkanje

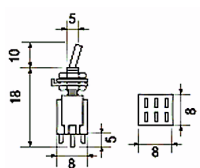

koda pak. pozicije
C4/6592 10 1-1

STIKALO ENOPOLNO



Stikalo enopolno ON/OFF
10A 250V, 15A 125V
enopolno
kontakti: na vijak M3

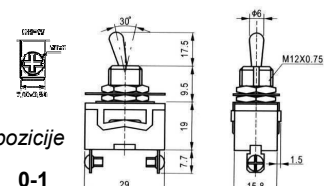

koda pakiranje pozicije
C4/6631 10 0-1

PREKLOPNIK MINI ENOPOLNI



Preklopnik mini
3A 250V, 6A 125V
enopolni
kontakti: na spajkanje

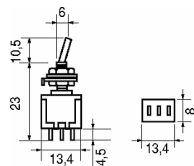

koda pakiranje pozicije
C4/6594 10 1-1

STIKALO DVOPOLNO



Stikalo dvopolno prof.
10A 250V, 15A 125V
dvopolno
kontakti: faston 6,3mm

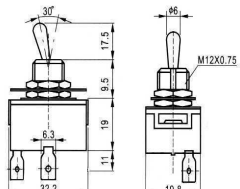

koda pakiranje pozicije
C4/6635 10 0-1

PREKLOPNIK MINI DVOPOLNI



Preklopnik mini
3A 250V, 6A 125V
dvopolni
kontakti: na spajkanje

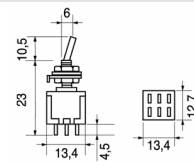

koda pakiranje pozicije
C4/6596 10 1-1

STIKALO ENOPOLNO



Stikalo ON/OFF
2A 250V, 4A 125V
enopolno
kontakti: na spajkanje

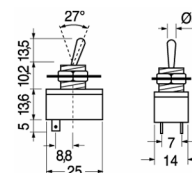

koda pakiranje pozicije
C4/6650 10 0-1

PREKLOPNIK 3 POZICIJE DVOPOLNI



Preklopnik mini 3 pozicije
3A 250V, 6A 125V
dvopolni
kontakti: na spajkanje

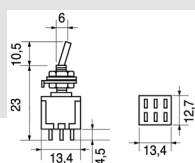

koda pakiranje pozicije
C4/6595 10 1-0-2
C4/6597 1 nestabilno - 0 - 1
C4/6598 1 nestabilno - 0 - nestabilno

PREKLOPNIK ENOPOLNI



Preklopnik enopolni prof.
10A 250V, 15A 125V
enopolni
kontakti: faston 6,3mm

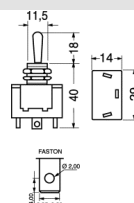

koda pakiranje pozicije
C4/6700 10 1-1

PREKLOPNIK DVOPOLNI



Preklopnik enopolni prof.
10A 250V, 15A 125V
dvopolni
kontakti: faston 6,3mm

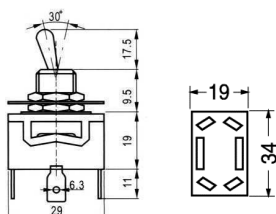

koda	pakiranje	pozicije
C4/6705	1	1-1

PREKLOPNIK 3 POZICIJE ENOPOLNI



Preklopnik enopolni prof.
10A 250V, 15A 125V
enopolni
kontakti: faston 6,3mm

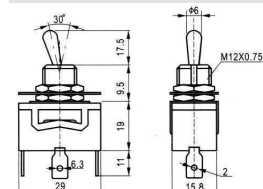

koda	pakiranje	pozicije
C4/6702	1	1 - 0 - 2

PREKLOPNIK 3 POZICIJE DVOPOLNI



Preklopnik dvopolni prof.
10A 250V
dvopolni
kontakti: faston 6,3mm

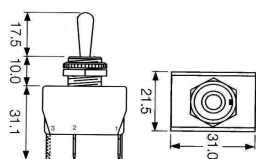

koda	pakiranje	pozicije
C4/6706B	1	nestabilno - 0 - nestabilno

STIKALO fi 15mm ENOPOLNO



Stikalo v obliki tipke
1A 250V
enopolno
ohišje: makrolon
kontakti: na spajkanje

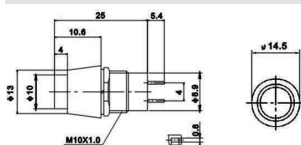

koda	pak.	barva
C4/6550	10	rdeča

STIKALO Z LUČKO ENOPOLNO

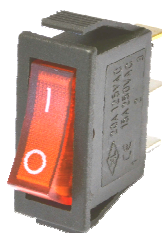

Stikalo z lučko
16A 250V, 20A 125V
z vgrajeno tlviko 230V
enopolno
ohišje: ABS
kontakti: faston 6,3mm

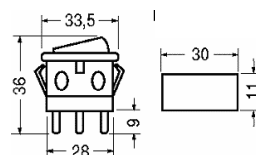

koda	pak.	barva
C4/7102	10	rdeča
C4/7102Z	10	zelena

STIKALO Z LUČKO DVOPOLNO



Stikalo z lučko dvopolno za GORENJE
10A 250V
z vgrajeno tlviko 230V
dvopolno
kontakti: faston 6,3mm

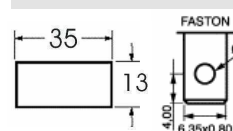

Koda	pakiranje	barva
C4/7103R	10	rdeča
C4/7103Z	10	zelena
C4/7103O	10	oranžna

PREKLOPNIK ENOPOLNI



Preklopnik enopolni
16A 250V
enopolno
ohišje: ABS
kontakti: faston 6,3mm

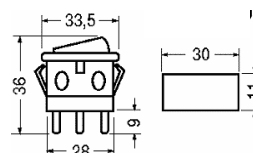

koda	pak.	pozicije
C4/7102-4	10	1-1

PREKLOPNIK 3 POZICIJE ENOPOLNI



Preklopnik 3 pozicije enopolno 16A 250V
enopolno
ohišje: ABS
kontakti: faston 6,3mm

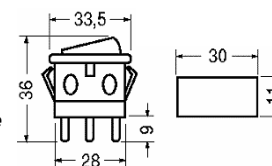

koda	pak.	pozicije
C4/7102-81-5	10	I-0-II

www.unoelektronika.si
uno.elektronika@siol.net
tel. 05 76-56-140

STIKALO Z LUČKO DVOPOLNO



Stikalo dvopolno z lučko
16A 250V, 20A 125V,
35A 12V
z vgrajeno tlviko 230V
ohišje: ABS dvopolno
kontakti: faston 6,3mm

koda	pak.	barva
C4/7148	10	rdeča
C4/7148O	10	oranžna
C4/7148Z	10	zelena

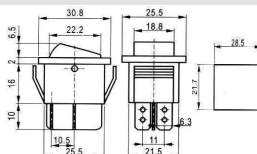

STIKALO DVOPOLNO



Stikalo dvopolno z belo tasto
16A 250V
dvopolno
ohišje: ABS
kontakti: faston 6,3mm

koda	pak.	pozicije
C4/6884	10	0-1

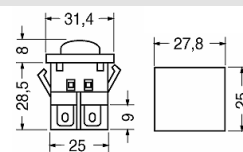

PREKLOPNIK DVOPOLNI



Preklopnik dvopolni
16A 250V
dvopolno
ohišje: ABS
kontakti: faston 6,3mm

koda	pak.	barva
C4/7148-82-4	10	črna

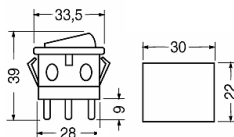

PREKLOPNIK 3 POZICIJE DVOPOL.



Preklopnik 3 pozicije dvopolno 16A 250V
dvopolno
ohišje: ABS
kontakti: faston 6,3mm

koda	pak.	pozicije
C4/7148-82-5	10	I-0-II

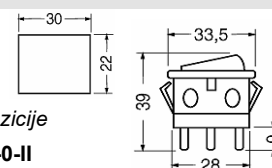

PREKLOPNIK DVOJNI ENOPOLNI



Preklopnik dvojni enopolni
16A 250V
enopolni
ohišje: ABS
kontakti: faston 6,3mm

koda	pak.	barva tasta
C4/7052	10	črna

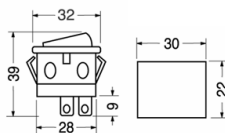

STIKALO Z LUČKO fi 20mm



Stikalo z lučko fi 20mm
6A 250V, 10A 125V
z vgrajeno tlviko 250V
enopolno
ohišje: makrolon
kontakti: faston 4,8mm

koda	pak.	barva
C4/6541	10	rdeča

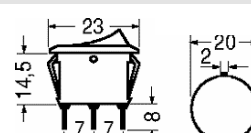

STIKALO DVOJNO Z LUČKO



Stikalo dvojno z lučko
10A 250V, 16A 125V
enopolno
z vgrajeno tlviko 230V
ohišje: ABS
kontakti: faston 6,3mm

koda	pak.	barva tasta
C4/7058	10	rdeča

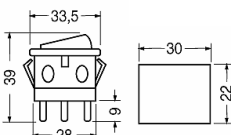

STIKALO DVOPOLNO Z LUČKO



Stikalo dvopolno z lučko
6A 250V
dvopolno, z vgrajeno tlviko
ohišje: nylon ojačan
kontakti: faston 4,8mm

koda	pak.	barva taste
C4/7163	10	rdeča

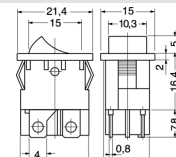

STIKALO DVOJNO ENOPOLNO



Stikalo dvojno
16A 250V
enopolno
ohišje: ABS
kontakti: faston 6,3mm

koda	pak.	barva tasta
C4/7156	5	rdeča

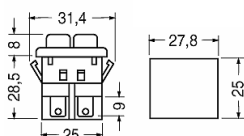

PREKLOPNIK ENOPOLNI



Preklopnik enopolni
6A 250V, 10A 125V
enopolni
ohišje: nylon ojačan
kontakti: faston 4,8mm

koda	pak.	pozicije
C4/7163	10	1-1

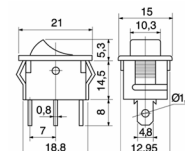

PREKLOPNIK 3 POZICIJE ENOPOLNI



Preklopnik 3 pozicije
10A 250V
enopolni
ohišje: nylon ojačan
kontakti: faston 4,8mm

koda pak. pozicije
C4/7172A 10 1-0-2

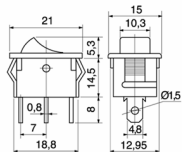

PREKLOPNIK Z VZVODOM MIKRO

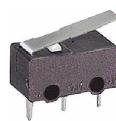

Preklopnik z vzvodom
1A 250V
ohišje: pvc
kontakti: za tiskano vezje

koda pak. sila za preklop
C4/7427 10 40gr

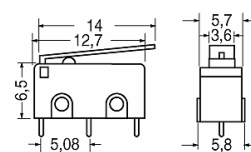

PREKLOPNIK Z VZVODOM

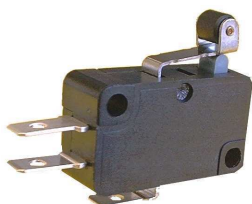

Preklopnik z kratkim vzvodom in drsnikom
5A 250V
ohišje: pvc
kontakti: faston 4,8mm

koda pak. sila za preklop
C4/7421 10 80gr

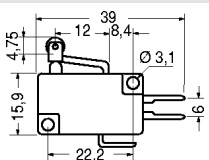

PREKLOPNIK Z VZVODOM

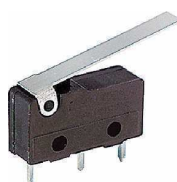

Preklopnik z vzvodom
3A 250V
ohišje: pvc
kontakti: za tiskano vezje

koda pak. sila za preklop
C4/7431 10 28gr

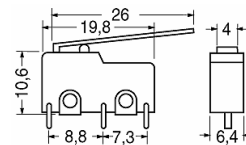

PREKLOPNIK Z VZVODOM

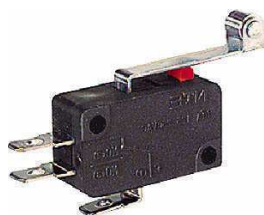

Preklopnik z vzvodom in drsnikom
5A 250V
ohišje: pvc
kontakti: faston 4,8mm

koda pak. sila za preklop
C4/7422 10 80gr

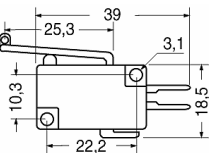

PREKLOPNIK Z VZVODOM



Preklopnik z vzvodom
3A 250V
ohišje: pvc
kontakti: na spajkanje

koda pak. sila za preklop
C4/7432 10 28gr

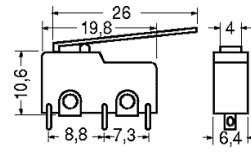

PREKLOPNIK Z VZVODOM

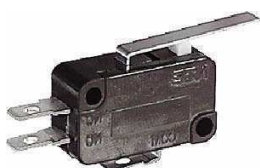

Preklopnik z vzvodom
5A 250V
ohišje: pvc
kontakti: faston 4,8mm

koda pak. sila za preklop
4/7424 10 60gr

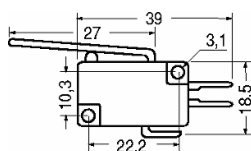

PREKLOPNIK Z VZVODOM



Preklopnik z vzvodom in drsnikom
3A 250V
ohišje: pvc
kontakti: na spajkanje

koda pak. sila za preklop
C4/7433 10 70gr

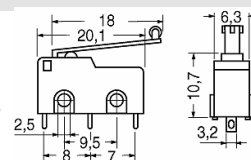

PREKLOPNIK Z VZVODOM

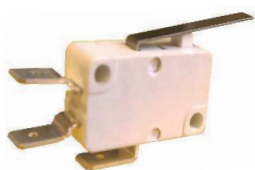

Preklopnik z vzvodom
16A 250V
ohišje: pvc
kontakti: faston 6,3mm

koda pak. sila za preklop
4/7424B 10 120gr

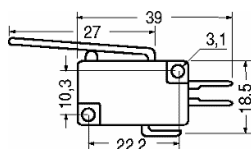

AVTOMATSKI ODKLOPNIK-STIKALO

Avtomatski termični odklopnik - stikalo z lučko 230VAC
Za vklopjanje in varovanje enosmernih ali izmeničnih tokokrogov, npr. na plovilih. Ima vgrajeno tlivko 230VAC. Rdeča tasta.
Delovna napetost: do 50 VDC ali 250 VAC 50/60Hz
Čas resetiranja: 6s.
Kontakti: faston 6,3mm

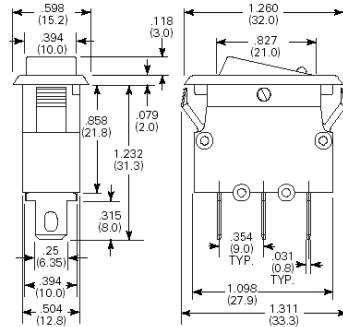

koda	prekinitveni tok	tlivka	pakirano
VOA05A	5 A	rdeča 230VAC	1 kos
VOA10A	10 A	rdeča 230VAC	1 kos
VOA15A	15 A	rdeča 230VAC	1 kos
VOA20A	20 A	rdeča 230VAC	1 kos

PREKLOPNIK VRTLJIVI

Preklopnik vrtljivi 2 polni 6 pozicij, zaprtega tipa za na tiskano vezje
150mA 250VAC, 300mA 30VDC
kontakti: za na tiskano vezje



koda	pozicije	polov	pakiranje
C4I7391	6	2	5

V IZDELAVI

AVTOMATSKI ODKLOPNIK-STIKALO

Avtomatski termični odklopnik - stikalo
Za vklopjanje in varovanje enosmernih ali izmeničnih tokokrogov, npr. na plovilih.
Črna tasta.
Delovna napetost: do 50 VDC ali 250 VAC 50/60Hz
Čas resetiranja: 6s.
Kontakti: faston 6,3mm

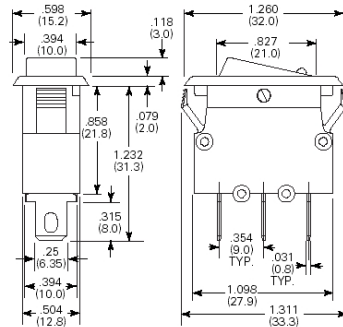

koda	prekinitveni tok	pakirano
VOB10A	10 A	1 kos
VOB20A	20 A	1 kos

V IZDELAVI

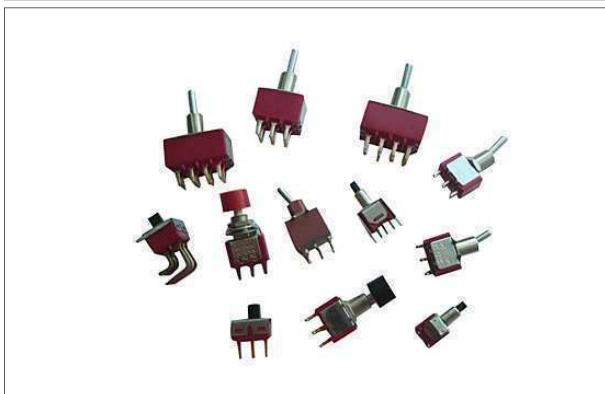

KONEKTORJI JACK 2,5mm

VTIKAČ JACK 2,5mm STEREO



koda pakiranje
C4/2990 10

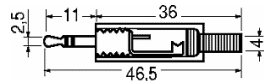

VTIČNICA JACK 2,5mm STEREO



koda pakiranje
C4/3202 10

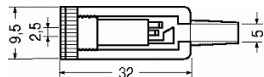

KONEKTORJI JACK 3,5mm

VTIKAČ JACK 3,5mm MONO



koda pakiranje
C4/3010 10

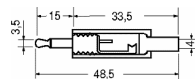

VTIKAČ JACK 3,5mm STEREO



koda pakiranje
C4/3004 10

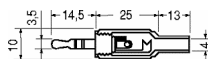

VTIKAČ JACK 3,5mm STEREO KOVINSKI



koda pakiranje
C4/3006 10

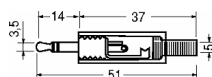

VTIČNICA JACK 3,5mm STEREO



koda pakiranje
C4/3220 10

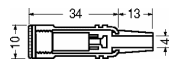

VTIČNICA JACK 3,5mm STEREO ZA PANEL S STIKALOM



koda pakiranje
C4/3106 10

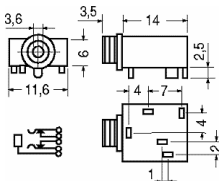

KONEKTORJI JACK 6,3mm

VTIKAČ JACK 6,3mm MONO



koda pakiranje
C4/3030 10

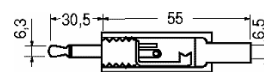

VTIKAČ JACK 6,3mm STEREO



koda pakiranje
C4/3040 10

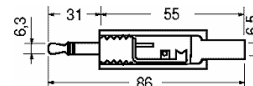

VTIKAČ JACK 6,3mm MONO KOVINSKI



koda pakiranje
C4/3032 10

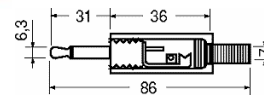

VTIKAČ JACK 6,3mm STEREO KOVINSKI



koda pakiranje
C4/3042 10

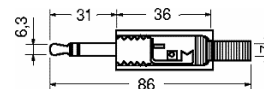

VTIKAČ JACK 6,3mm MONO KOTNI KOVINSKI



koda pakiranje
C4/3034 1

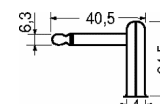

VTIKAČ JACK 6,3mm MONO, VODILO IZ GUME



koda barva pakiranje
C4/3049B črna



VTIKAČ JACK 6,3mm STEREO, VODILO IZ GUME



koda barva pakiranje
C4/3052 črna 10



KONEKTORJI JACK 6,3mm

VTIKAČ JACK 6,3mm MONO KOVINSKI - POZLAČEN



koda pakiranje
C4/3032B 5

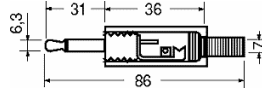

VTIKAČ JACK 6,3mm STEREO KOVINSKI - POZLAČEN



koda pakiranje
C4/3042C 5

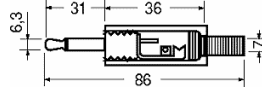

VTIČNICA JACK 6,3mm STEREO



koda pakiranje
C4/3240 10

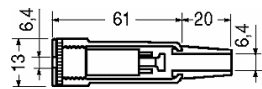

VTIČNICA JACK 6,3mm STEREO KOVINSKA



koda pakiranje
C4/3242 5

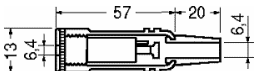

VTIČNICA JACK 6,3mm MONO, VODILO IZ GUME



koda barva pakiranje
C4/3235 črna 10

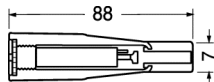

VTIČNICA JACK 6,3mm STEREO, VODILO IZ GUME



koda barva pakiranje
C4/3245 črna 10

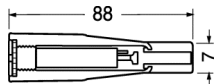

VTIČNICA JACK 6,3mm STEREO ZA NA PANEL



koda pakiranje
C4/3142 10

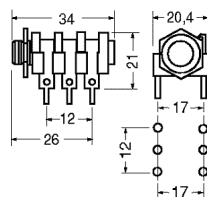

KONEKTORJI CANNON

VTIKAČ CANNON 3 POLNI



koda pakiranje
C4/4821 10

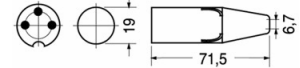

VTIČNICA CANNON 3 POLNA



koda pakiranje
C4/4823 10

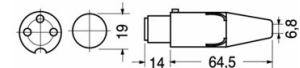

VTIKAČ CANNON 3 POLNI - NEUTRIK NC3MXX



koda pakiranje
C4/4821N 1

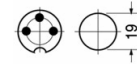

VTIČNICA CANNON 3 POLNA - NEUTRIK NC3FXF



koda pakiranje
C4/4823N 1

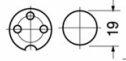

VTIKAČ CANNON 3 POLNI VGRADNI



koda pakiranje
C4/4829 10

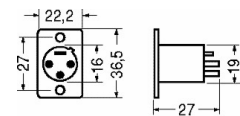

VTIČNICA CANNON 3 POLNA VGRADNA



koda pakiranje
C4/4827 10

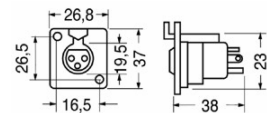

V IZDELAVI

MIKROFONSKI KONEKTORJI

VTIČNICA Z OKLOPOM ZA MIKROFON

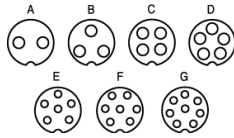

koda	št. polov	pak.	slika
C4/5610	2	10	A
C4/5611	3	10	B
C4/5612	4	10	C
C4/5613	5	10	D
C4/5616	8	10	G

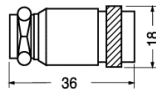

V IZDELAVI

VTIKAČ Z OKLOPOM ZA MIKROFON - VGRADNI

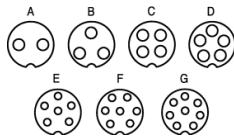

koda	št. polov	pak.	slika
C4/5620	2	10	A
C4/5621	3	10	B
C4/5622	4	10	C
C4/5623	5	10	D
C4/5626	8	10	G



V IZDELAVI

VTIKAČ Z OKLOPOM ZA MIKROFON

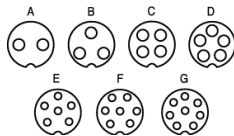

koda	št. polov	pak.	slika
C4/5640	2	10	
C4/5641	3	10	A
C4/5642	4	10	B
C4/5643	5	10	
C4/5646	8	10	C

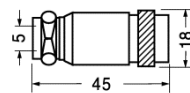

ADAPTER JACK

ADAPTER VTIČNICA JACK 3,5mm NA VTIKAČ JACK 2,5mm - STEREO



Koda	pak.
C4/33300	5

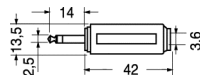

V IZDELAVI

V IZDELAVI

KONEKTORJI ČRTA PIKA

VTIKAČ ČRTA PIKA KONTAKTI NA SPAJKANJE



koda pakiranje
C4/200 10

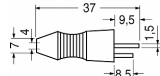

VTIKAČ ČRTA PIKA KONTAKTI NA VIJAK



koda pakiranje
C4/205 10

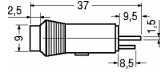

VTIKAČ ČRTA PIKA POD KOTOM KONTAKTI NA VIJAK



koda pakiranje
C4/210 10

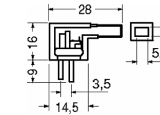

VTIKAČ ČRTA PIKA KONTAKTI NA PRITISK



koda pakiranje
C4/211 50

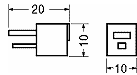

VTIČNICA ČRTA PIKA KONTAKTI NA VIJAK



koda pakiranje
C4/805 10

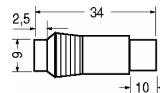

VTIČNICA ČRTA PIKA ZA NA PANEL



koda pakiranje
C4/10 10

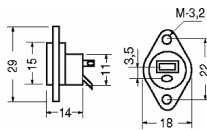

PRIKLJUČEK ZA ZVOČNE OMARICE

PRIKLJUČEK 2 POLNI ZA ZVOČNE OMARICE



koda pakiranje
C4/2068 10

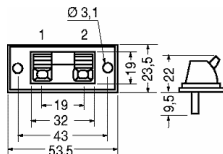

KONEKTORJI DIN

VTIKAČ DIN 5 POLNI



koda pakiranje
C4/260 10

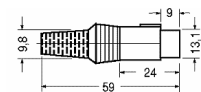

VTIKAČ DIN 4+1 POLNI ZA SLUŠALKE



koda pakiranje
C4/270 5

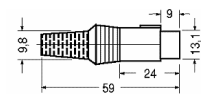

VTIČNICA DIN 5 POLNA



koda pakiranje
C4/660 5

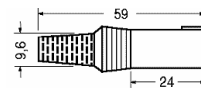

VTIČNICA DIN 5 POLNA ZA NA PANEL



koda pakiranje
C4/60 5

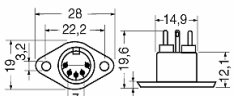

KONEKTORJI MINI DIN

VTIKAČ MINI DIN 4 POLNI S-VHS



koda pakiranje
C5/2850 1



ADAPTER MINI DIN 4 POLNI S-VHS / VTIČNICA RCA



Spremeni S-VHS signal v video kompozitni signal.



koda pakiranje
KVR45/7352 1

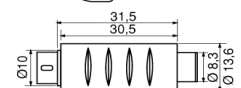

UNO elektronika d.o.o.

Dolenja vas 1b, 6224 Senožeče
tel. 05 76-56-140 fax. 05 76-56-141

Dobavljivi iz zaloge, tudi drugi tipi konektorjev ki niso prisotni v tem katalogu:

BNC, PL, UHF, TNC, N, F, FME, MINI DIN, SCART, JM, SMA, SMB, SUB, ADAPTERJI,.....

KONEKTORJI RCA

VTIKAČ RCA

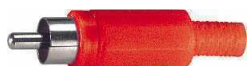

koda	pakiranje	barva
C4/2000	10	rdeča
C4/2001	10	rumena
C4/2002	10	črna
C4/2003	10	plava

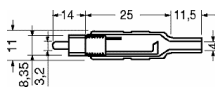

VTIKAČ RCA POZLAČEN



koda	pakiranje	barva
C4/1976	10	rdeča
C4/1978	10	črna

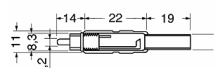

VTIKAČ RCA KOVINSKI POZLAČEN



koda	pakiranje	barva
C4/1920B	4	rdeča
C4/1920C	4	črna

VTIČNICA RCA

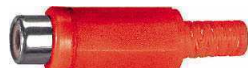

koda	pakiranje	barva
C4/2020	10	rdeča
C4/2021	10	rumena
C4/2022	10	črna
C4/2023	10	plava

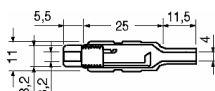

VTIČNICA RCA POZLAČENA



koda	pakiranje	barva
C4/2036	10	rdeča
C4/2038	10	črna

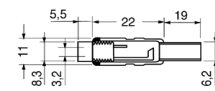

VTIČNICA RCA ZA NA PANEL



koda	pakiranje	barva
C4/2049	10	rdeča
C4/2050	10	črna

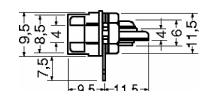

VTIČNICA RCA ZA NA PANEL POZLAČENA



koda	pakiranje	barva
C4/2044	1	rdeča
C4/2046	1	črna

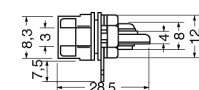

KONEKTORJI RCA

VTIČNICA ZA NA PANEL 2x RCA



koda	pakiranje
C4/2060	1

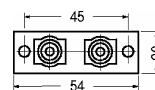

KONEKTORJI BANANA

VTIKAČ BANANA fi 4mm



koda	pakiranje	barva
C4/3520	10	rdeča
C4/3522	10	črna

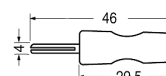

VTIKAČ BANANA fi 4mm HIRSHMAN



koda	pakiranje	barva
C4/3526	10	rumena
C4/3527	10	rdeča
C4/3528	10	plava
C4/3529	10	črna

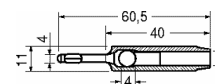

VTIČNICA BANANA fi 4mm



koda	pakiranje	barva
C4/3460	5	rdeča
C4/3461	5	črna

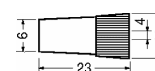

VTIČNICA BANANA fi 4mm ZA NA PANEL



koda	pakiranje	barva
C4/3600	10	rdeča
C4/3602	10	črna

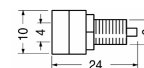

VTIČNICA BANANA fi 4mm ZA NA PANEL



koda	pakiranje	barva
C4/3710	10	rdeča
C4/3712	10	črna

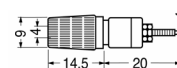

VTIČNICA BANANA 30A, fi 4mm ZA NA PANEL



koda	pakiranje	barva
C4/3726	10	rdeča
C4/3728	10	črna

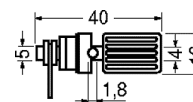

**ADAPTER VTIČNICA JACK 3,5
STEREO NA VTIKAČ JACK 3,5**



Adapter:
vtičnica jack 3,5mm stereo
na vtičač jack 3,5mm mono.

koda pakiranje
C4/35300 1

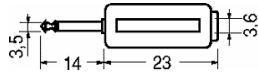

**ADAPTER VTIČNICA RCA NA
VTIČNICO RCA**



Adapter:
vtičnica RCA na vtičnico RCA.

koda pakiranje
C4/42600 1

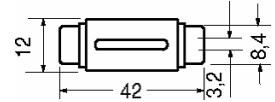

**ADAPTER VTIČNICA RCA NA
VTIKAČ JACK 3,5 MONO**



Adapter:
vtičnica RCA na vtičač jack
3,5mm mono.

koda pakiranje
C4/35600 1

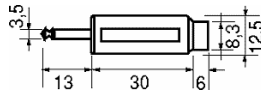

**ADAPTER 2 VTIČNICI JACK 3,5 NA
VTIKAČ JACK 3,5**



Adapter:
2 vtičnici jack 3,5mm stereo
na vtičač jack 3,5mm stereo.

koda pakiranje
C4/47625 1

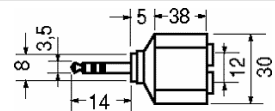

**ADAPTER VTIČNICA JACK 6,3 NA
VTIKAČ JACK 3,5**



Adapter:
vtičnica jack 6,3mm stereo na
vtičač 3,5mm stereo.

koda pakiranje
C4/36500 5

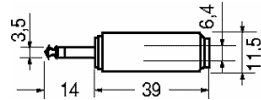

**ADAPTER 2 VTIČNICI RCA NA
VTIKAČ JACK 3,5**



Adapter:
2 vtičnici RCA na vtičač jack
3,5mm stereo.

koda pakiranje
C4/47800 1

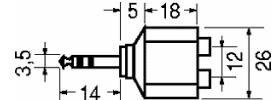

**ADAPTER VTIČNICA RCA NA
VTIKAČ JACK 6,3 MONO**



Adapter:
vtičnica RCA na vtičač jack
6,3mm mono.

koda pakiranje
C4/38600 1

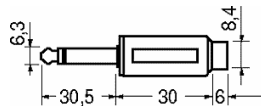

**ADAPTER 2 VTIČNICI RCA NA
VTIKAČ JACK 6,3**



Adapter:
2 vtičnici RCA na vtičač jack
6,3mm stereo.

koda pakiranje
C4/48800 1

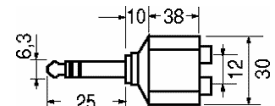

**ADAPTER VTIČNICA JACK 3,5 NA
VTIKAČ JACK 6,3**



Adapter:
vtičnica jack 3,5mm stereo na
vtičač jack 6,3mm stereo.

koda pakiranje
C4/39300 5

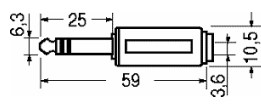

**ADAPTER 2 VTIČNICI RCA NA
VTIKAČ RCA**



Adapter:
2 vtičnici RCA na vtičač RCA.

koda pakiranje
C4/49300 1

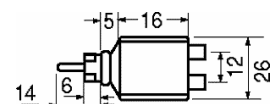

KONEKTORJI BNC

VTIKAČ BNC



koda	za kabel	ohm	pak.
C5/20310	RG58	50	10
C5/20330	RG59	75	10

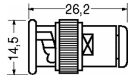

VTIKAČ BNC NA KRIMPANJE



koda	za kabel	ohm	pak.
C5/20002	RG174	50	10
C5/20010	RG58	50	10
C5/20025	RG59	75	10
C5/20035	RG62	93	10

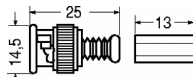

VTIČNICA BNC NA KRIMPANJE



koda	za kabel	ohm	pak.
C5/22010	RG58	50	5
C5/22020	RG59	75	5

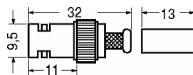

ZAKLJUČNI UPOR BNC



koda	ohm	pak.
C5/20700	50	5
C5/20705	75	5

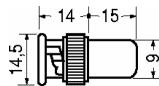

ADAPTER 2x VTIČNICA BNC, 1 ČLEN



koda	pak.	ohm
C5/45500	5	univerz.

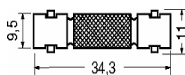

ADAPTER VTIKAČ BNC NA 2 VTIČNICI BNC



koda	pak.	ohm
C5/45020	5	univerz.

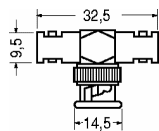

ADAPTER 2xVTIČNICA BNC ZA NA PANEL



koda	pak.	ohm
C5/45521	5	univerz.

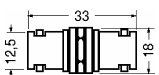

KONEKTORJI BNC

VTIČNICA BNC PANEL



Koda	pak.
C5/23380	5

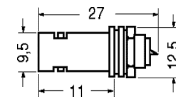

ADAPTER 2x VTIČNICA BNC ZA NA PANEL IZOLIRANA



koda	pak.
C5/45524	5

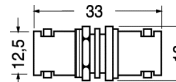

ADAPTER

ADAPTER VTIČNICA RCA NA VTIKAČ BNC



koda	pak.	ohm
C5/45475	5	univerz.

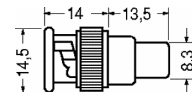

KONEKTORJI F

VTIKAČ F



koda	za Ø kabla	pak.	slika	opomba
C5/24300	5mm	10	A	
C5/24400	6,2mm	10	A	
C5/24427	5mm	10	B	na krimpnanje

ADAPTER 2x VTIČNICA F ZA NA PANEL



koda	pak.	ohm
C5/46570	10	75

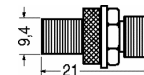

KONEKTOR ADAPTER

ADAPTER VTIČNICA F NA HITRI VTIKAČ F

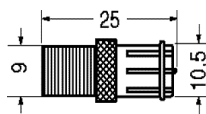

koda *pakiranje*
C5/46060 **5**

ADAPTER VTIČNICA F NA HITRO VTIČNICO IEC

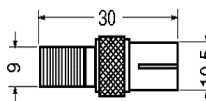

koda *pakiranje*
C5/46985 **5**

ADAPTER VTIKAČ F NA VTIKAČ IEC

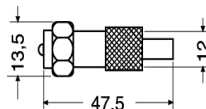

Koda *pakiranje*
C5/46500 **5**

ADAPTER VTIKAČ F NA VTIČNICO IEC

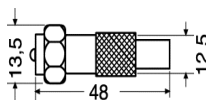

Koda *pakiranje*
C5/46485 **5**

ADAPTER VTIČNICA F NA VTIKAČ IEC

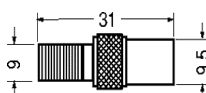

Koda *pakiranje*
C5/46990 **5**

ADAPTER VTIČNICA F NA VTIKAČ RCA

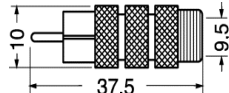

Koda *pakiranje*
C5/46980 **5**

UNO elektronika d.o.o.

Dolenja vas 1b, 6224 Senožeče

tel. 05 76-56-140 fax. 05 76-56-141

mail: uno.elektronika@siol.net

KONEKTOR ADAPTER

ADAPTER VTIKAČ F NA VTIKAČ F

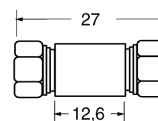

koda *pakiranje*
C5/46075 **5**

ADAPTER VTIČNICA F NA VTIČNICO F, ZA PANEL

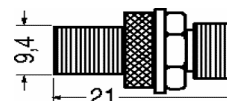

koda *pakiranje*
C5/46570 **10**

ADAPTER VTIČNICA F NA VTIKAČ BNC

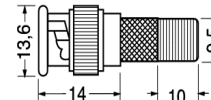

Koda *pakiranje*
C5/45050 **5**

ADAPTER VTIČNICA F NA VTIČNICO BNC

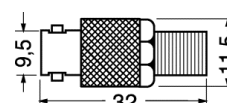

Koda *pakiranje*
C5/45550 **5**

KONČNI UPOR NA F VTIKAČ 75 Ohm IZOLIRAN



Koda *pakiranje*
AFCR75F **5**

KONČNI UPOR 75 Ohm



Koda *pakiranje*
AFCR75 **5**

TULJAVA ZA PRENOS NAPETOSTI



Koda *pakiranje*
AFIZ2 **5**

KONEKTORJI UHF

VTIKAČ UHF (PL 258)



koda	za kabel	ohm	pak.
C5/39150	RG58	50	5
C5/39210	RG213U	50	5

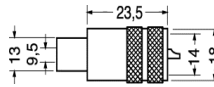

VTIKAČ UHF (PL 258) NA KRIMPANJE



koda	za kabel	ohm	pak.
C5/39030	RG213U	50	5

VTIČNICA UHF (PL 258)



koda	za kabel	ohm	pak.
C5/40210	RG58	50	5

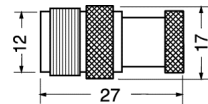

VTIČNICA UHF VGRADNA



koda	pak.	ohm
C5/40710	5	50

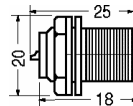

ADAPTER 2x VTIČNICA UHF



koda	pak.	ohm
C5/54925	5	50

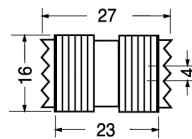

KONEKTORJI N

VTIKAČ N



koda	za kabel	ohm	pak.
C5/27310	RG58	50	5
C5/27352	RG213U	50	5

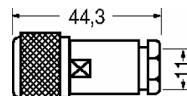

UNO elektronika d.o.o.
Dolenja vas 1b, 6224 Senožeče
tel. 05 76-56-140 fax. 05 76-56-141

KONEKTORJI TNC

VTIKAČ TNC REVERS NA KRIMPANJE



koda	kabel	pakiranje
X3780	RG58, H155	1

VTIKAČ TNC REVERS NA KRIMPANJE



koda	kabel	pakiranje
X3782	RG6, H500	1

VTIČNICA TNC REVERS ZA KABEL H-155 NA KRIMPANJE



koda	kabel	pakiranje
X3784	RG58, H155	1

KONEKTORJI FME

VTIKAČ FME ZA KABEL RG174 NA KRIMPANJE



koda	kabel	pak.
C5/26140	RG174	1

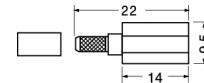

KONEKTORJI SMA

VTIKAČ SMA ZA KABEL RG174 NA KRIMPANJE

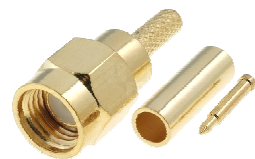

koda	kabel	pak.
C5/34000	RG174	1

VTIKAČ SMA ZA KABEL RG58 NA KRIMPANJE



koda	kabel	pak.
C5/34005	RG58	1

V IZDELAVI

KONEKTORJI SPEAKON

VTIKAČ SPEAKON 4 POLNI

koda pakiranje
C4/5002B 1



VTIČNICA SPEAKON 4 POLNA

koda pakiranje
C4/5000B 1



VTIČNICA SPEAKON 4 POLNA ZA NA PANEL

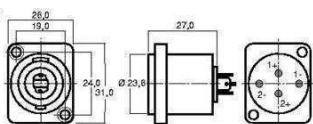

koda pakiranje
C4/5004B 1



V IZDELAVI

V IZDELAVI

UNO elektronika d.o.o.

Dolenja vas 1b, 6224 Senožeče

tel. 05 76-56-140 fax. 05 76-56-141
mail: uno.elektronika@siol.net

VTIKAČ ZA NA KABEL

Signalni vtičač za na kabel

št. polov: 12 in 17
kontakti: pozlačeni, na spajkanje,
označeni s številkami
ohišje: kovinsko, kromirano
za nominalne napetosti do: 150V
nominalni tok: 8A
stopnja zaščite: IP68
premer kabla: od 9mm do 13mm
za vodnike do: 1mm²
konektor zatesnjen z: O-ringom

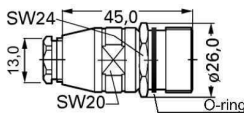

koda polov pakiranje
C4/5670 12 1
C4/5672 17 1

VTIČNICA ZA NA KABEL

Signalna vtičnica za na kabel

št. polov: 12 in 17
kontakti: pozlačeni, na spajkanje,
označeni s številkami
ohišje: kovinsko, kromirano
za nominalne napetosti do: 150V
nominalni tok: 8A
stopnja zaščite: IP68
premer kabla: od 9mm do 13mm
za vodnike do: 1mm²

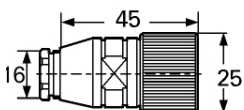

koda polov pakiranje
C4/5674 12 1
C4/5676 17 1

VTIKAČ ZA NA PANEL

Signalni vtičač za na panel

št. polov: 12 in 17
kontakti: pozlačeni, na spajkanje,
označeni s številkami
ohišje: kovinsko, kromirano
za nominalne napetosti do: 150V
nominalni tok: 8A
stopnja zaščite: IP68
konektor je zatesnjen z O-ringom
in tesnilom.

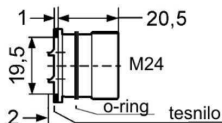

koda polov pakiranje
C4/5680 12 1
C4/5682 17 1

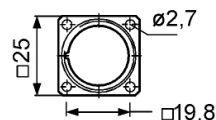

VTIČNICA ZA NA PANEL

Signalna vtičnica za na panel

št. polov: 12 in 17
kontakti: pozlačeni, na spajkanje,
označeni s številkami
ohišje: kovinsko, kromirano
za nominalne napetosti do: 150V
nominalni tok: 8A
stopnja zaščite: IP68



koda polov pakiranje
C4/5684 12 1
C4/5686 17 1

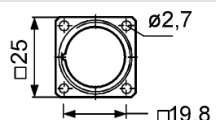

KONEKTORJI EURO

VTIKAČ EURO 3 POLNI 10A 250V, PROFI K+B



koda pakiranje
M13/790 5

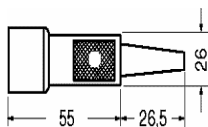

VTIČNICA EURO 3 POLNA 10A 250V, PROFI K+B



koda pakiranje
M13/845 5

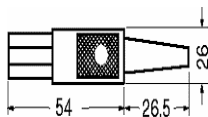

VTIČNICA EURO 3 POLNA KOTNA 10A 250V, K&B



koda pakiranje
M13/855 5

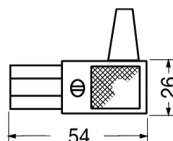

VTIKAČ EURO 3 POLNI VGRADNI 15A 250V



koda	priklop	pakiranje
M13/895	faston 4,8mm	5
M13/895B	faston 6,3mm	5

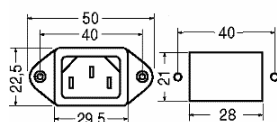

VTIČNICA EURO 3 POLNA VGRADNA 10A 250V



koda	priklop	pakiranje
M13/940	faston 4.8mm	5
M13/940B	faston 6,3mm	5

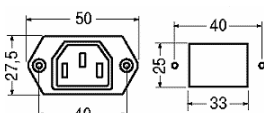

KONEKTORJI EURO

VTIKAČ EURO 3 POLNI VGRADNI 6A 250V Z OMREŽNIM FILTROM PROTI MOTNJAM, PRIKLOP FASTON 6,3mm



koda pakiranje
M13/1750 1

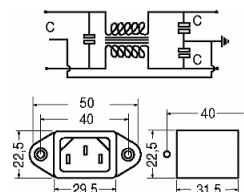

VTIKAČ EURO 3 POLNI VGRADNI 3A 250V Z OMREŽNIM FILTROM PROTI MOTNJAM IN NOSILCEM VAROVALKE 5x20mm, PRIKLOP FASTON 6,3mm.



koda pakiranje
M13/1760 1

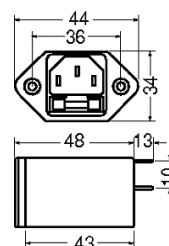

VTIKAČ EURO 3 POLNI VGRADNI (SNAP IN) 6A 250V Z OMREŽNIM FILTROM PROTI MOTNJAM IN DVOJNIM NOSILCEM VAROVALKE 5x20mm. PRIKLOP FASTON 6,3mm.

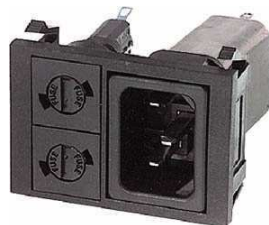

koda pakiranje
M13/1790 1

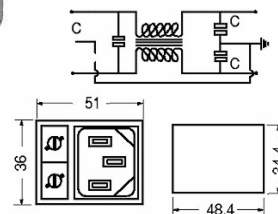

VTIKAČ EURO 3 POLNI VGRADNI 6A 250V Z OMREŽNIM FILTROM PROTI MOTNJAM, DVOJNIM NOSILCEM VAROVALKE 5x20mm IN STIKALOM. PRIKLOP FASTON 6,3mm.



koda pakiranje
M13/1810 1

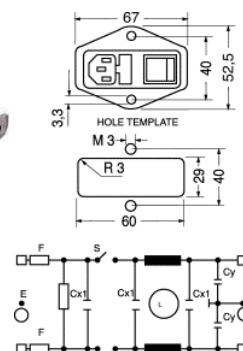

KONEKTORJI NAPAVALNI

VTIČNICA ZA NAPAJANJE

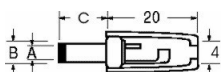

koda	fi zunanji B	fi notranji A	dolžina C	pak.
C4/2560	5mm	2,1mm	14mm	10
C4/2565	5mm	2,5mm	14mm	10
C4/2572	5,5mm	2,1mm	9,5mm	10
C4/2580	3,4mm	1,3mm	9,5mm	10
C4/2582	3,8mm	1mm	9,5mm	10
C4/2585	2,5mm	0,7mm	9,5mm	10

VTIČNICA ZA NAPAJANJE



koda	fi zunanji B	fi notranji A	dolžina C	pak.
C4/2570	5,5mm	2,5mm	9,5mm	10
C4/2576	6,3mm	3,1mm	9,5mm	10
C4/2584	3mm	1,1mm	9,5mm	10
C4/2591	4mm	1,7mm	9,5mm	10

VTIKAČ ZA NAPAJANJE

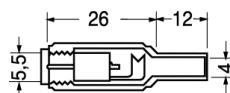

koda	fi zunanji B	fi notranji A	pak.
C4/2520	5,5mm	2,1mm	10
C4/2521	5,5mm	2,5mm	10

VTIKAČ ZA NAPAJANJE S STIKALOM ZA NA PANEL

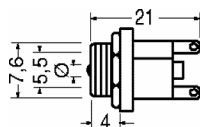

koda	fi zunanji	fi notranji pin	pakiranje
C4/2512	5,5mm	2,1mm	10
C4/2514	5,5mm	2,5mm	10

NAPAVALNA VRVICA ZA 9V BATERIJSKI VLOŽEK



koda	pakiranje
C4/11012	10

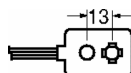

UNO elektronika d.o.o.
Dolenja vas 1b, 6224 Senožeče
tel. 05 76-56-140 fax. 05 76-56-141

NOSILCI BATERIJ

NOSILEC 2 BATERIJ TIPA AA



koda	pakiranje
C4/11000	5

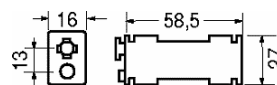

NOSILEC 3 BATERIJ TIPA AA

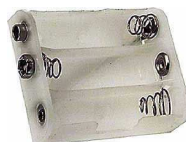

koda	pakiranje
C4/10997	5



NOSILEC 4 BATERIJ TIPA AA



koda	pakiranje
C4/11002	5

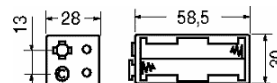

NOSILEC 4 BATERIJ TIPA AA VZPOREDNO



koda	pakiranje
C4/11005	5

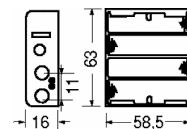

NOSILEC 10 BATERIJ TIPA AA



koda	pakiranje
C4/11009	5

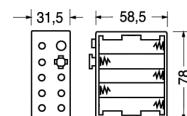

KONEKTORJI SUB

VTIČNICE SUB

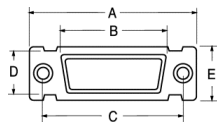
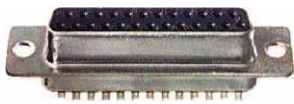

koda	polov	dimenzije:	A	B	C	pakiranje
C5/6100	9		31	18	25,3	10
C5/6102	15		39	26	33,3	10
C5/6106	25		53	40	47,0	10
C5/6108	37		69	57	63,5	5

VTIKAČI SUB

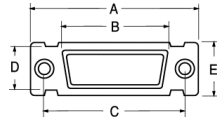
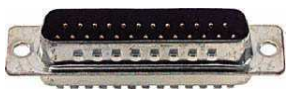

koda	polov	dimenzije:	A	B	C	pakiranje
C5/6120	9		31	18	25,3	10
C5/6122	15		39	26	33,3	10
C5/6124	25		53	40	47,0	10
C5/6126	37		69	57	63,5	5

VTIČNICA SUB HD

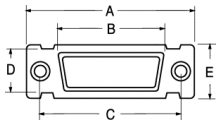

koda	polov	dimenzije:	A	B	C	pakiranje
C5/5870	15		31	18	25,3	10

VTIKAČ SUB HD

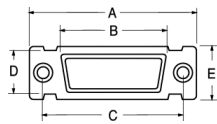

koda	polov	dimenzije:	A	B	C	pakiranje
C5/5890	15		31	18	25,3	10

VTIČNICA SUB ZA FLAT KABEL

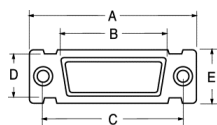

koda	polov	dimenzije:	A	B	C	pakiranje
C5/6330	9		31	18	25,3	10

VTIKAČ SUB ZA NA TISKANO VEZJE 90°

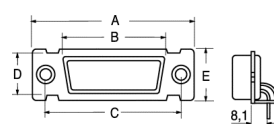

koda	polov	dimenzije:	A	B	C	pakiranje
C5/6442	15		31	18	25,3	10



OHIŠJA ZA SUB KONEKTORJE

OHIŠJA PLASTIČNA ZA SUB KONEKTORJE

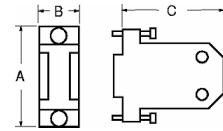

koda	polov	dimenzije:	A	B	C	pakiranje
C5/6600	9		31	16	44	10
C5/6605	15		39	16	44	10
C5/6610	25		53	16	44	10
C5/6615	37		70	16	44	5

KONEKTORJI IDC

VTIČNICA IDC ZA FLAT KABEL

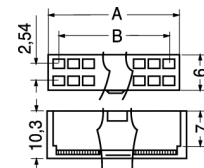

koda	polov	dimenzije:	A	B	pakiranje
C5/8050	10		17,3	13,7	10
C5/8055	16		24,8	21,3	10

V IZDELAVI



KONEKTORJI NAPAVALNI ATX

VTIKAČ NAPAVALNI 4 POLNI ZA NAPAVALNIK ATX



koda	opis	pakiranje	
X487	ohišje 4 polno brez pinov	10	
X488	pin moški za kabel AWG24-18	100	

VTIČNICA NAPAVALNA 4 POLNA ZA NAPAVALNIK ATX



koda	opis	pakiranje	
X4871	ohišje 4 polno brez pinov	10	
X4881	pin ženski za kabel AWG24-18	100	

KONEKTORJI MINI-FIT JR MOLEX

VTIČNICA MINI-FIT JR MOLEX

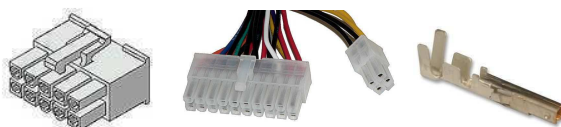

koda	opis	art. MOLEX	pakiranje	
X75006	ohišje 4 p.	39-01-2040	10	
X663	ohišje 12 p.	39-01-2125	10	
X75018	ohišje 14p.	39-01-2140	10	
X75009B	pin moški za kabel AWG24-18		100	

VTIKAČ MINI-FIT JR MOLEX



koda	opis	art. MOLEX	pakiranje	
X75007	ohišje 4 p.	39-01-2041	10	
X75008B	pin moški za kabel AWG24-18		100	

KONEKTORJI MICROFIT 3.0 MOLEX

VTIČNICA MICROFIT 3.0 MOLEX



koda	opis	art. MOLEX	pakiranje	
XM430250200	ohišje 2 p.	43025-0200	10	
XM430300007	pin ženski za kabel AWG20-24		100	

UNO elektronika d.o.o.
Dolenja vas 1b, 6224 Senožeče

KONEKTOR MOLEX #3,96mm

VTIČNICA MOLEX #3,96mm



koda	opis	art. MOLEX	pakiranje	
X75030	ohišje 6 p.	09-91-0600	10	
X75031	pin moški za kabel AWG24-18		100	

KONEKTOR MINI MATE-N-LOK AMP

VTIKAČ MINI MATE-N-LOK

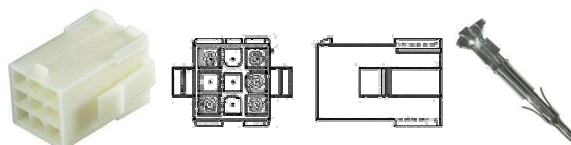

koda	opis	art. AMP	pakiranje	
C98/51420B	ohišje 12 p.	172333-1	10	
C98/51440B	pin moški za kabel AWG22-18		100	

V IZDELAVI

V IZDELAVI

MREŽNI ADAPTERJI

ADAPTER ITALIJANSKA VTIČNICA - SHUKO VTIKAČ



koda **MV00301B** pakiranje **10**

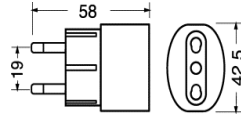

ADAPTER VTIČNICA USA - VTIKAČ SLO

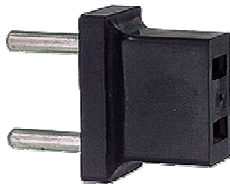

koda **MV01352B** pakiranje **10**

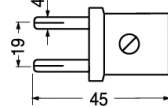

ADAPTER VTIČNICA SHUKO - VTIKAČ ITALIJANSKI



koda **MV01356B** pakiranje **10**

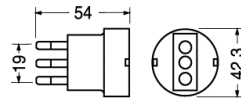

ADAPTER VTIČNICA USA, IT, AUSTRALIJA, ANGLIJA, NZ, NA VTIKAČ SHUKO



koda **MV01358B** pakiranje **10**

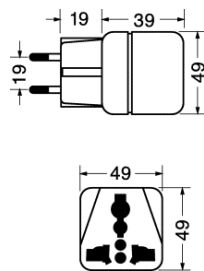

UNIVERZALNI MREŽNI ADAPTER ZA USA, NZ, AUS, EU, UK, CN, SLO



koda **MV01360** pakiranje **1**

V IZDELAVI

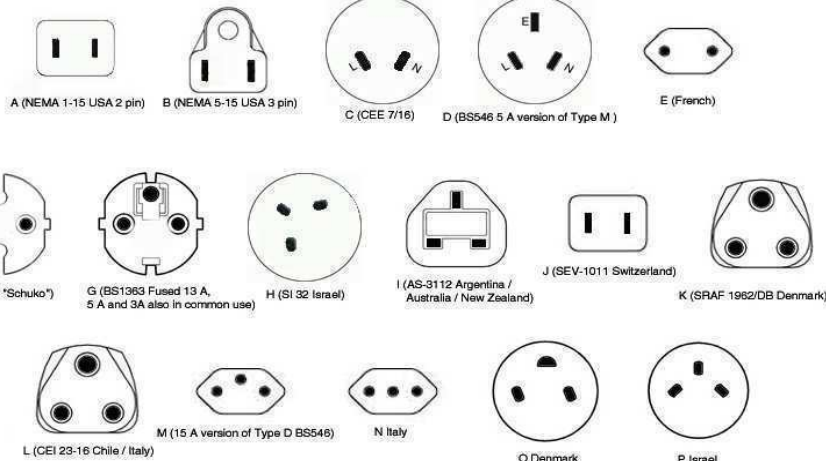

**UNIVERZALNI STABILIZIRANI
NAPAJALNIK 1000mA**



**Stabilizirani switching
napajalnik 1000mA**

Stabilizirani napajalnik z nastavljivo napetostjo in polarizacijo. Priloženi so izhodni priključki, raznih dimenzij in oblik + USB priključek.

SPLOŠNI PODATKI:
napajanje: 100 - 240VAC
napetosti na izhodu:
3 - 4,5 - 5 - 6 - 7,5 - 9 - 12VDC
izhodni tok: 1000mA

Napajalnik je zaščiten proti kratkemu stiku in preobremenitvam.

koda pak.
W13/245 1

**UNIVERZALNI STABILIZIRANI
NAPAJALNIK 2500mA**



**Univerzalni stabilizirani
napajalnik 2500mA.**

Kompaktni stabilizirani napajalnik z nastavljivo napetostjo in polarizacijo. Priloženi so izhodni priključki, raznih dimenzij in oblik.

SPLOŠNI PODATKI:
napajanje: 100 - 250V~
napetosti na izhodu:
16-17-18-19-20-24V
izhodni tok do 20V: 2500mA
izhodni tok 24V: 2250mA max.

Primeren za napajanje prenosnih PC-jev, tiskalnikov,

Koda pak.
W13/260 1

**UNIVERZALNI STABILIZIRANI
NAPAJALNIK 2250mA**



**Stabilizirani switching
napajalnik 2250mA**

Stabilizirani napajalnik z nastavljivo napetostjo in polarizacijo. Priloženi so izhodni priključki, raznih dimenzij in oblik + USB priključek.

SPLOŠNI PODATKI:
napajanje: 100 - 240VAC
napetosti na izhodu:
3 - 4,5 - 5 - 6 - 7,5 - 9 - 12VDC
izhodni tok: 2250mA

Napajalnik je zaščiten proti kratkemu stiku in preobremenitvam.

koda pak.
W13/252 1

**UNIVERZALNI STABILIZIRANI
NAPAJALNIK 6000mA ZA PC**



**Univerzalni stabilizirani
napajalnik 6000mA za PC.**

Kompaktni stabilizirani napajalnik **switching** z nastavljivo napetostjo, polarizacijo in veliko dodatnih priključkov.

SPLOŠNI PODATKI:
napajanje: 100 - 250V~
napetosti na izhodu:
15-16-18-19-20-22-24VDC
izhodni tok do 20V: 6000mA
izhodni tok 22-24V: 5000mA max.

Primeren za napajanje prenosnih PC-jev, tiskalnikov,...

Koda pak.
W13/265 1

**STABILIZIRANI NAPAJALNIK
12V 2500mA**



**Stabilizirani switching
napajalnik 12V 2500mA.**

Kompaktni stabilizirani napajalnik z fiksnim izhodom in nastavljivo polarizacijo. in veliko dodatnih priključkov. Priloženi so izhodni priključki, raznih dimenzij in oblik.

SPLOŠNI PODATKI:
napajanje: 100 - 240V~
napetost na izhodu: 12VDC
izhodni tok: 2500mA maks.
dimenzije: 86x62x30mm
teža: 86g

Koda pak.
W13/292 1

**NAPAJALNIK / PRETVORNIK ZA PC,
IZ 12VDC, 6000mA**



**Univerzalni napajalnik/
pretvornik iz 12VDC,
6000mA za PC.**

Kompaktni stabilizirani napajalnik **switching** z nastavljivo napetostjo, polarizacijo in veliko dodatnih izhodnih priključkov.

SPLOŠNI PODATKI:
napajanje: 12VDC (iz avto vžigalnika)
napetosti na izhodu:
15-16-18-19-20-22-24VDC
izhodni tok do 20V: 6000mA
izhodni tok 22-24V: 5000mA max.

Primeren za napajanje prenosnih PC-jev, tiskalnikov, modemov,...

Koda pak.
W13/277 1

**UNIVERZALNI STABILIZIRANI
NAPAJALNIK 1500 - 3800mA**



Univerzalni stabilizirani napajalnik 1500 - 3800mA za PC.

Kompaktni stabilizirani napajalnik switching, z nastavljivo napetostjo v korakih po 1V. Nastavljiva polarizacija napetosti na izhodu. Priloženi so izhodni priključki, raznih dimenzij in oblik in veliko dodatnih svetovnih adapterjev: angleški, evropski, ameriški in avstralski vtičič. Izhodno napetost nastavljate s pomočjo priloženih uporov.

SPLOŠNI PODATKI:
napajanje: 100 - 240V~
nastavljive napetosti na izhodu:

- | | |
|-------------|------------|
| 5V 3800mA, | 6V 3700mA |
| 7V 3600mA, | 8V 3500mA |
| 9V 3400mA, | 10V 3300mA |
| 11V 3200mA, | 12V 3000mA |
| 13V 2700mA, | 14V 2500mA |
| 15V 2400mA, | 16V 2200mA |
| 17V 2100mA, | 18V 2000mA |
| 19V 1880mA, | 20V 1800mA |
| 21V 1700mA, | 22V 1630mA |
| 23V 1560mA, | 24V 1500mA |

Primeren za napajanje prenosnih PC-jev, tiskalnikov, modemov,....

koda pak.
W13/255 1

**UNIVERZALNI STABILIZIRANI
NAPAJALNIK 12V 4000mA**



Univerzalni stabilizirani napajalnik 12V 4000mA

Kompaktni stabilizirani napajalnik switching, z fiksno napetostjo na izhodu.

SPLOŠNI PODATKI:

napajanje: 100 - 240V~
napetost na izhodu: 12VDC
izhodni tok: 4000mA

priključek na izhodu: zunanji Ø 5,5mm, notranji Ø 2,1mm
+ polariteta na notranjem pinu.
dolžina omrežnega kabla: 1m
dolžina napajalnega kabla: 1m

Primeren za napajanje prenosnih PC-jev, tiskalnikov, modemov, video kamer....

Koda pak.
W13/294B 1

V IZDELAVI

**UNIVERZALNI STABILIZIRANI
NAPAJALNIK 1200mA**



Stabilizirani switching napajalnik 1200mA.

Kompaktni stabilizirani napajalnik switching, z nastavljivo napetostjo in polariteto. Priloženi so izhodni priključki, raznih dimenzij in oblik.

SPLOŠNI PODATKI:

napajanje: 100 - 240V~
napetosti na izhodu:
3 - 4,5 - 6 - 7,5 - 9 - 12VDC
Maksimalni izhodni tok:
1200mA (14,4VA)

Primeren za napajanje prenosnih PC-jev, tiskalnikov, modemov,....

Koda pak.
W13/286 1

V IZDELAVI

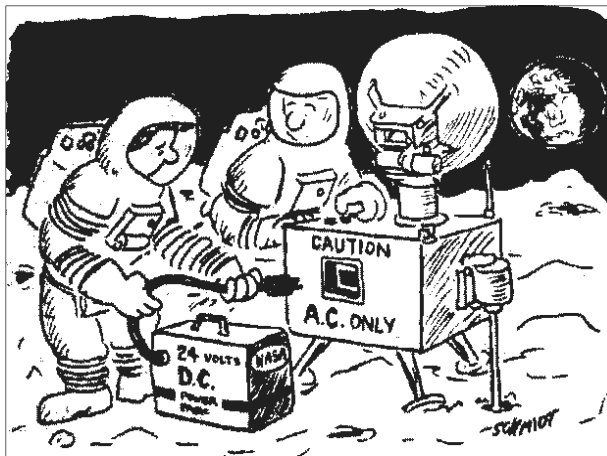

**NAPAJALNIK STABILIZIRANI
PROFESIONALNI 13,8V 5A**



**Napajalnik stabilizirani
standard 13,8V= 5A**

Fiksna in stabilizirana enosmerna napetost na izhodu. Elektronska zaščita proti preobremenitvam in kratkim stikom.

SPLOŠNI PODATKI:

napajanje: 230V~
napetost na izhodu: 13,8V=
±0,5V stabilizirana
delovni neprekinjeni tok: 3A
maksimalni tok: 5A
ripple: 20mV
temperatura delovanja:
od -10°C do +40°C
dimenzije: 140x74x185mm
teža: 2Kg

koda pak.

W13/10100 1

**NAPAJALNIK STABILIZIRANI
PROFESIONALNI 13,8V 7A**



**Napajalnik stabilizirani
profesionalni 13,8V= 7A**

Fiksna in stabilizirana enosmerna napetost na izhodu. Elektronska zaščita proti preobremenitvam in kratkim stikom.

SPLOŠNI PODATKI:

napajanje: 230V~
napetost na izhodu: 13,8V=
±0,2V stabilizirana
delovni neprekinjeni tok: 4,5A
maksimalni tok: 7A
ripple: 5mV
temperatura delovanja:
od -10°C do +40°C
dimenzije: 170x85x220mm

koda pak.

W13/10200 1

**POLNILEC ZA SUHO SVINČENE
(Pb) BATERIJE**



**Polnilec za suho svinčene
(Pb) baterije 6V in 12V**

Fiksna in stabilizirana enosmerna napetost na izhodu.
Primerna za polnjenje 6V in 12V Pb baterije s kapaciteto od 1Ah do 10Ah.

SPLOŠNI PODATKI:

napajanje: 230V~
priključki faston 6,3mm

koda za baterije izhod maks. izhodni tok

BN30/8704	6V	6,9V	800mA
BN30/8711	12V	13,8V	700mA

**NAPAJALNIK PROFESIONALNI Z
REGULACIJO NAPETOSTI 3-30V 2,5A**



**Napajalnik profesionalni z
regulacijo napetosti 3-30V
in toka 0-2,5A**

Nastavljiva napetost in tok na izhodu. Digitalni instrument na 3 digit meri napetost in tok na izhodu. Elektronsko zaščiten proti preobremenitvam in kratkim stikom na izhodu. Zelo nizki ripple. Namenjen za napajanje laboratorijskih instrumentov, avtoradijev, ojačevalcev,....

SPLOŠNI PODATKI:

napajanje: 230V~
nastavljiva napetost: 3 do 30V
maksimalni izhodni tok: 2,5A
stabilizacija na izhodu: ±0,2V
ripple: 3mV
temperatura delovanja:
od -10°C do +40°C
dimenzije: 170x85x255mm
teža: 3,5Kg
ohišje: kovinsko

koda pak.

W13/11000 1

V kompletu spadata navodila in električna shema.

Garancija 12 mesecev.

**NAPAJALNIK PROFESIONALNI Z
REGULACIJO NAPETOSTI 3-30V 5A**



**Napajalnik profesionalni z
regulacijo napetosti 3-30V
in toka 0-5A**

Nastavljiva napetost in tok na izhodu. Dva digitalna instrumenta na 3 digit merita napetost in tok na izhodu. Elektronsko zaščiten proti preobremenitvam in kratkim stikom na izhodu. Zelo nizki ripple. Namenjen za napajanje laboratorijskih instrumentov, avtoradijev, ojačevalcev,....

SPLOŠNI PODATKI:

napajanje: 230V~
nastavljiva napetost: 3 do 30V
maksimalni izhodni tok: 5A
stabilizacija na izhodu: ±0,2V
ripple: 3mV
temperatura delovanja:
od -10°C do +40°C
dimenzije: 220x115x325mm
teža: 4,8Kg
ohišje: kovinsko

koda pak.

W13/11100 1

V kompletu spadata navodila in električna shema.

Garancija 12 mesecev.

**NAPAJALNIK PROFESIONALNI Z
REGULACIJO NAPETOSTI 1,5-15V 5A**



Napajalnik profesionalni z regulacijo napetosti 1,5-15V in toka 0-5A

Nastavljiva napetost in tok na izhodu. Digitalni instrument na 3 digit meri napetost in tok na izhodu. Elektronsko zaščiten proti preobremenitvam in kratkim stikom na izhodu. Zelo nizki ripple. Namenjen za napajanje laboratorijskih instrumentov, avtoradijev, ojačevalcev,.....

SPLOŠNI PODATKI:

napajanje: 230V~
nastavljiva napetost: od 1,5V do 15V
maksimalni izhodni tok: 5A
stabilizacija na izhodu: $\pm 0,2V$
ripple: 3mV
temperatura delovanja: od -10°C do +40°C
dimenzije: 170x85x255mm
teža: 5,5Kg
ohišje: kovinsko

V kompletu spadata navodila in električna shema.

koda pak.
W13/11200 1

**UNIVERZALNI POLNILEC Ni-Mh in
Ni-Cd BATERIJ S TIMERJEM**



Univerzalni polnilec Ni-Mh in Ni-Cd baterij. Ima vgrajen timer. Prazni in polni. Ima vgrajen test za baterije.

Lahko polnimo:
4x AAA 1,5V
4x AA 1,5V
4x C 1,5V
4x D 1,5V
2x 9V
Napajanje: 230V

koda pak.
BN30/8605 1

**HITRI POLNILEC
Ni-Mh in Ni-Cd BATERIJ**



Hitri polnilec Ni-Mh in Ni-Cd baterij tipa AA

Priložene 4 baterije Ni-Mh 2500mAh
Samodejno prazni, polni in eliminira spominski efekt baterij. Lahko polnimo od 1 do 4 baterij tipa AA
Ultra hitro polnjenje.
Vse funkcije uravnava vgrajen procesor.

Napajanje: iz avtovžigalnika 12VDC, in na omrežno napetost 230VAC. Priključna kabla sta priložena.

koda pak. priložene baterije Ni-Mh
BN30/8619 1 4xAA 2.500mAh

**HITRI POLNILEC
Ni-Mh in Ni-Cd BATERIJ**



Hitri polnilec Ni-Mh in Ni-Cd baterij tipa AAA, AA, C, 9V in D.

Samodejno prazni, polni in eliminira spominski efekt baterij. Lahko polnimo od 2 do 4 baterij tipa AA, AAA, C, D in po eno 9V baterijo. Čas polnenja baterij kapacitete 2200mAh je 3,5h. Vse funkcije uravnava vgrajen procesor.

Napajanje: omrežna napetost 230V

koda pak.
BN30/8610 1

**UNIVERZALNI POLNILEC
Ni-Mh in Ni-Cd BATERIJ**



Univerzalni polnilec Ni-Mh in Ni-Cd, do 10 baterij

Nastavljivo št baterij: 1 do 10.
Nastavljivi tok polnenja: 50, 100, 200, 300, 400, 500 in 600mA
Nastavljiv čas polnenja: 0,5, 1, 3, 4, 6 in 8 ur.
Po končanem polnjenju se samodejno izklopi.

Napajanje: omrežna napetost 230V

koda pak.
BN30/8669 1

**UNIVERZALNI AVTO NAPAJALNIK
800mA**



Univerzalni avto napajalnik 800mA

Napajalnik z nastavljivo napetost in polarizacijo. Vklopi se ga v avto vžigalnik.

SPLOŠNI PODATKI:
napajanje: 12V=
napetosti na izhodu: 3 - 4,5 - 6 - 7,5 - 9 - 12V
maksimalni tok: 800mA

koda pak.
W8/1600 1

UNO elektronika d.o.o.

Dolenja vas 1b
6224 Senožeče

tel. 05 76-56-140
fax. 05 76-56-141
e-mail: uno.elektronika@siol.net
www.unoelektronika.si

INDUSTRIJSKI NAPAVALNIKI MEAN WELL

Industrijski switching napajalnik za na DIN letev. Izhod 24VDC.

Delovna napetost 100 - 260VAC.

Odlikuje ga visoki izkoristek in nizka delovna temperatura. Na izhodu so 105°C kondenzatorji. Je zaščiten proti kratkemu stiku pregrevanju in preobremenitvam. Mehki zagon. Vgrajen EMI filter proti motnjam. Modeli nad 10A imajo vgrajen PFC filter (Power Factor Correction). Zgrajeni po standardu ISO-9001.

Podroben opis in karakteristike na <http://www.meanwellusa.com> Ostali modeli po naročilu!



2A 24VDC 48W

Izhodna napetost: 24VDC
 Delovni izhodni tok: 0 do 2A
 Izhodna moč: 48W
 Nastavljiva izhodna napetost: 21,6 do 24,4V
 Šum na izhodu (ripple): max. 480mVp-p
 Izhodna regulacija: ±1%
 Napajanje: 85 - 264VAC
 Možna preobremenitev: 105 - 150% izhodne moči
 Zaščita proti pregrevanju pri: +135°C (izklop, avtomatski vklop po ohladitvi)
 Delovna temperatura: -10 do +50°C
 Dimenzije in teža: 93x78x63mm, 0,31Kg

koda UNO	koda MEAN WELL	izhodna napetost	izhodna moč	pakiranje
W13/20140B	DR-45-24	24VDC	48W	1



3A 24VDC 75W

Izhodna napetost: 24VDC
 Delovni izhodni tok: 0 do 3A
 Izhodna moč: 75W
 Nastavljiva izhodna napetost: 24 do 28V
 Šum na izhodu (ripple): max. 150mVp-p
 Izhodna regulacija: ±0,5%
 Napajanje: 85 - 264VAC
 Možna preobremenitev: 105 - 150% izhodne moči
 Zaščita proti pregrevanju pri: +85°C (izklop, avtomatski vklop po ohladitvi)
 Delovna temperatura: -10 do +60°C
 Dimenzije in teža: 55,5x125,2x100mm, 0,6Kg

koda UNO	koda MEAN WELL	izhodna napetost	izhodna moč	pakiranje
W13/20150B	DR-75-24	24VDC	75W	1



120W

Izhodna napetost: 24VDC (12VDC)
 Delovni izhodni tok: 0 do 5A (0 do 10A)
 Izhodna moč: 120W
 Nastavljiva izhodna napetost: 24 do 28V (12 DO 14V)
 Šum na izhodu (ripple): max. 80mVp-p
 Izhodna regulacija: ±0,5%
 Napajanje: 88 - 132 in 176 - 264VAC nastavljivo
 Možna preobremenitev: 105 - 150% izhodne moči
 Zaščita proti pregrevanju pri: +85°C (izklop, avtomatski vklop po ohladitvi)
 Delovna temperatura: -10 do +60°C
 Dimenzije in teža: 100x65,5x125,2mm, 0,65Kg

koda UNO	koda MEAN WELL	izhodna napetost	izhodna moč	pakiranje
W13/20152B	DR-120-24	24VDC	120W	1
W13/20160A	DR-120-12	12VDC	120W	1



10A 24VDC 240W

Izhodna napetost: 24VDC
 Delovni izhodni tok: 0 do 10A
 Izhodna moč: 240W
 Nastavljiva izhodna napetost: 24 do 28V
 Šum na izhodu (ripple): max. 80mVp-p
 Izhodna regulacija: ±0,5%
 Napajanje: 85 - 264VAC nastavljivo
 Vgrajen PFC (Power Factor Correction)
 Možna preobremenitev: 105 - 150% izhodne moči
 Zaščita proti pregrevanju pri: +100°C (izklop, avtomatski vklop po ohladitvi)
 Delovna temperatura: -10 do +70°C
 Dimenzije in teža: 125,5x125,5x100mm, 1,1Kg

koda UNO	koda MEAN WELL	izhodna napetost	izhodna moč	pakiranje
W13/20160B	DRP-240-24	24VDC	240W	1

PRETVORNIK IZ 230V NA 110V 45W



Pretvornik iz 230 na 110V 45W

Z 2 polnim vtikačem in 2 polno USA vtičnico.

Vhodna napetost: 220/230V
Izhodna napetost: 110V
Maksimalna moč: 45W

Koda pak.
W13/212 1

PRETVORNIK IZ 110V NA 230V 45W



Pretvornik iz 110 na 230V 45W

Z 2 polnim USA vtikačem in shuko vtičnico.

Vhodna napetost: 110V
Izhodna napetost: 230V
Maksimalna moč: 45W

Koda pak.
W13/210 1

PRETVORNIK IZ 24VDC NA 12VDC, 10A



Pretvornik iz 24VDC (avtobus, kamion) na 12VDC, maks. 10A

Namenjen za napajanje avtoradijev, CB postaj, in ostale aparate s tokom do 10A.

SPLOŠNI PODATKI:

vhodna napetost: 24VDC
izhodna napetost: 12VDC
maksimalni izhodni tok: 10A

Zaščiten proti pregrevanju in preobremenitvam.

koda pak.
W13/213B 1

PRETVORNIK IZ 12Vcc NA 230Vca 50Hz, 150W



koda pak.
W13/16000 1

VICTORY-e CE

Pretvornik iz 12Vcc na 230Vca 50Hz, moči 150W.

Omogoča pretvorbo enosmerne napetosti baterije 12V na izmenično 230V 50Hz.

SPLOŠNI PODATKI:

napetost na vhodu: 10-15VCC
napetost na izhodu: 230Vac
frekvenca na izhodu: 50Hz
oblika izhodne napetosti: modificirana sinusoida
nazivna moč: 150W stalnih
maksimalna izhodna moč za kratek čas: 300W
tok pri nazivni moči: 15A /12V
priključek na vhodu: avto vtikač
priključek na izhodu: shuko vtičnica

Pretvornik je zaščiten proti kratkemu stiku in pregrevanju. Ima zaščito proti izpraznitvi baterije,...

Primeren za napajanje: žarnic, ventilatorjev, prenosnih računalnikov,....

dimenzije: 125x73x70mm
teža: 0,6Kg

Garancija 12 mesecev.

UNO elektronika d.o.o.

Dolenja vas 1b
6224 Senožeče

tel. 05 76-56-140

fax. 05 76-56-141

www.unoelektronika.si

e-mail: uno.elektronika@siol.net

Po naročilu so dobavljivi tudi drugi napajalniki, pretvorniki, adapterji..., ki niso prisotni v tem katalogu!! Pokličite nas za ponudbo!!

**PRETVORNIK IZ 12Vcc NA
230Vca 50Hz, 350W**



koda pak.
W13/16100 1

VICTORY-e® CE

Pretvornik iz 12Vcc na 230Vca 50Hz, moči 350W.

Omogoča pretvorbo enosmerne napetosti baterije 12V na izmenično 230V 50Hz.

SPLOŠNI PODATKI:

napetost na vhodu: 10-15VCC
napetost na izhodu: 230Vac
frekvenca na izhodu: 50Hz
oblika izhodne napetosti: modificirana sinusoida
nazivna moč: 350W stalnih
maksimalna izhodna moč za kratek čas: 1000W
tok pri nazivni moči: 35A /12V
prikluček na vhodu: avto vtičač ali kabel s krokodili
prikluček na izhodu: shuko vtičnica

Pretvornik ima vgrajen ventilator, je zaščiten proti kratkemu stiku in pregrevanju. Ima zaščito proti izpraznjenju baterije,...

Primeren za napajanje: žarnic, ventilatorjev, malih TV, VCR, DVD, računalnikov,....

Ni primeren za napajanje hladilnikov, zaradi prevelikega zagonskega toka le teh!

dimenzije: 185x112x73mm
teža 1,35Kg

Garancija 12 mesecev.

**PRETVORNIK IZ 12Vcc NA
230Vca 50Hz, 600W**



koda pak.
W13/16200 1

VICTORY-e® CE

Pretvornik iz 12Vcc na 230Vca 50Hz, moči 600W.

Omogoča pretvorbo enosmerne napetosti baterije 12V na izmenično 230V 50Hz.

SPLOŠNI PODATKI:

napetost na vhodu: 10-15VCC
napetost na izhodu: 230Vac
frekvenca na izhodu: 50Hz
oblika izhodne napetosti: modificirana sinusoida
nazivna moč: 600W stalnih
maksimalna izhodna moč za kratek čas: 1500W
tok pri nazivni moči: 60A /12V
prikluček na vhodu: kabel s krokodili
prikluček na izhodu: shuko vtičnica

Pretvornik ima vgrajen ventilator, je zaščiten proti kratkemu stiku in pregrevanju. Ima zaščito proti izpraznjenju baterije,...

Primeren za napajanje: žarnic, ventilatorjev, malih TV, VCR, DVD, računalnikov, manjših vrtalnih strojev,...

Ni primeren za napajanje hladilnikov, zaradi prevelikega zagonskega toka le teh!

dimenzije: 280x200x70mm
teža 2,4Kg

Garancija 12 mesecev.

**PRETVORNIK IZ 24Vcc NA
230Vca 50Hz, 600W**



Pretvornik iz 24Vcc na 230Vca 50Hz, moči 600W.

Omogoča pretvorbo enosmerne napetosti baterije 24V na izmenično 230V 50Hz.

SPLOŠNI PODATKI:

napetost na vhodu: 20-30VCC
napetost na izhodu: 230Vac
frekvenca na izhodu: 50Hz
oblika izhodne napetosti: modificirana sinusoida
nazivna moč: 600W stalnih
maksimalna izhodna moč za kratek čas: 1500W
tok pri nazivni moči: 30A /24V
prikluček na vhodu: kabel s krokodili
prikluček na izhodu: shuko vtičnica

Pretvornik ima vgrajen ventilator, je zaščiten proti kratkemu stiku in pregrevanju. Ima zaščito proti izpraznjenju baterije,...

Primeren za napajanje: žarnic, ventilatorjev, malih TV, VCR, DVD, računalnikov, manjših vrtilnih storitev,...

Ni primeren za napajanje hladilnikov, zaradi prevelikega zagonskega toka le teh!

dimenzije: 280x200x70mm
teža 2,4Kg

Garancija 12 mesecev.

koda pak.
W13/16210 1



**PRETVORNIK IZ 12Vcc NA
230Vca 50Hz, 1500W**



Pretvornik iz 12Vcc na 230Vca 50Hz, moči 1500W.

Omogoča pretvorbo enosmerne napetosti baterije 12V na izmenično 230V 50Hz.

SPLOŠNI PODATKI:

napetost na vhodu: 10-15VCC
napetost na izhodu: 230Vac
frekvenca na izhodu: 50Hz
oblika izhodne napetosti: modificirana sinusoida
nazivna moč: 1500W stalnih
maksimalna izhodna moč za kratek čas: 3000W
tok pri nazivni moči: 170A /12V
prikluček na vhodu: kabel z očesnim čevljičkom
prikluček na izhodu: dve shuko vtičnici

Pretvornik ima vgrajen ventilator, je zaščiten proti kratkemu stiku in pregrevanju. Ima zaščito proti izpraznjenju baterije,...

Primeren za napajanje: žarnic, ventilatorjev, malih TV, VCR, DVD, računalnikov, manjših vrtilnih storitev,...

Je primeren za napajanje hladilnikov!

dimenzije: 458x210x85mm
teža: 5,5Kg

Garancija 12 mesecev.

koda pak.
W13/16500 1



MULTIMETER ANALOGNI NI 700

Multimeter analogni NI 700

SPLOŠNI PODATKI:

- * 4 merilna območja: enosmerna napetost in tok, izmenična napetost, upornost.
- * 15 merilnih dosegov
- * notranja upornost 2 KOhm/V
- * uporablja za delovanje eno samo baterijo AA 1,5V



MERILNI DOSEGI:

VCA: 10-50-250-500V
VCC: 2,5-10-50-250-500V
CC: 0,5mA-10mA-250mA
R: 2K -20K- 200KOhm
temperatura delovanja: 0°C do +40°C
napajanje: 1 baterija AA 1,5V
dimenzije: 64x100x30mm
teža: 120gr
ohišje: pvc
Namenjen je za hobby in manj zahtevne meritve.
V kompletu spadajo merilne veze, navodila in baterija.

koda pak. barva
19/7010 1 črna

Garancija 12 mesecev.

MULTIMETER ANALOGNI NI 900

Multimeter analogni NI 900

SPLOŠNI PODATKI:

- * 5 merilnih območij: enosmerna napetost in tok, izmenična napetost, upornost, ojačanje od -10 do +56dB, test baterij 1,5V in 9V
- * 16 merilnih dosegov
- * za delovanje potrebuje eno baterijo AA 1,5V.



MERILNI DOSEGI:

notranja upornost: 20KOhm/V
VCA: 10-50-500V
VCC: 2,5-10-50-250-500V
CC: 0,5mA-10mA-250mA
R: Rx10 -Rx1000 do 2MOhm
temperatura delovanja: od 0°C do +40°C
napajanje: 1 baterija AA 1,5V
dimenzije: 100x155x40mm
teža: 270gr
ohišje: pvc + gumi zaščita
V kompletu spadajo merilne veze, gumi zaščita, baterija in navodila.

koda pak. barva
19/7200 1 črna

Garancija 12 mesecev.

V IZDELAVI

V IZDELAVI

MULTIMETER DIGITALNI NI 2100

**Multimeter digitalni NI 2100
3 1/2 digit**

SPLOŠNI PODATKI:

- * 6 merilnih območij: enosmerna napetost in tok, izmenična napetost, upornost, preizkus diode in ojačanje tranzistorja,
- * 19 merilnih dosegov
- * za delovanje potrebuje eno samo 9V baterijo



MERILNI DOSEGI:

notranja upornost: 1MOhm
VCA: 200-600V
VCC: 200m-2-20-200-600V
CC: 200μ-2m-20m-200m-10A
R: 200-2K-20K-200K-2M Ohm
ojačanje tranzist.: hFE 0-1000
temperatura delovanja: od 0°C do +40°C
dimenzije: 75x145x40mm
teža: 200gr
ohišje: pvc + gumi zaščita
V kompletu spadajo merilne veze, navodila in 9V baterija.

koda pak. barva
19/7800 1 črna

Garancija 12 mesecev.

MULTIMETER DIGITALNI NI 3900



Multimeter digitalni NI 3900
3 1/2 digit
SPLOŠNI PODATKI:

- * 6 merilnih območij: enosmerna napetost in tok, izmenična napetost in tok, upornost, preizkus diode in ojačanje tranzistorja, preizkus prevodnosti z internim piskačem
- * 26 merilnih dosegov
- * za delovanje potrebuje eno samo 9V baterijo

MERILNI DOSEGI:

notranja upornost: 10MOhm
VCA: 20-200-600V
VCC: 200m-2-20-200-600V
CC: 200μ-2m-20m-200m-2A-10A
CA: 2m-20m-200m-2A-10A
R: 200-2K-20K-200K-2M-20M Ohm
ojačanje tranzist.: hFE 0-1000
temperatura delovanja: od 0°C do +40°C
dimenzije: 88x170x34mm
teža: 270gr ohišje: pvc
V kompletu spadajo merilne veze, navodila in baterija.

Garancija 12 mesecev.

koda pak. barva
I9/8000 1 črna

MULTIMETER DIGITALNI NI 4000



Multimeter digitalni NI 4000
3 1/2 digit
SPLOŠNI PODATKI:

- * 10 merilnih območij: enosmerna napetost in tok, izmenična napetost in tok, upornost, preizkus diode in ojačanje tranzistorja, preizkus prevodnosti z internim piskačem, kapacitivnost in temperatura
- * 32 merilnih dosegov
- * za delovanje potrebuje eno samo 9V baterijo

MERILNI DOSEGI:

notranja upornost: 10MOhm
VCA: 200m-2-20-200-700V
VCC: 200m-2-20-200-1000V
CC: 20μ-200μ-2m-20m-200m-2A-20A
CA: 2m-20m-200m-10A
R: 200-2K-20K-200K-2M-20M-200M Ohm
C: 2n-20n-200n-2μ-20μF
t: -20 do +400°C, 400-1000°C
ojačanje tranzistorja: hFE 0-1000
temperatura delovanja: od 0°C do +40°C
dimenzije: 91x198x32mm
teža: 310gr
ohišje: pvc + gumi zaščita

V kompletu spadajo merilne veze, sonda za merjenje temperature, gumi zaščita, baterija, navodila v slovenščini.

Garancija 12 mesecev.

koda pak. barva
I9/8105 1 črna

MULTIMETER DIGITALNI NI 8000
AUTORANGE 4 DIGIT

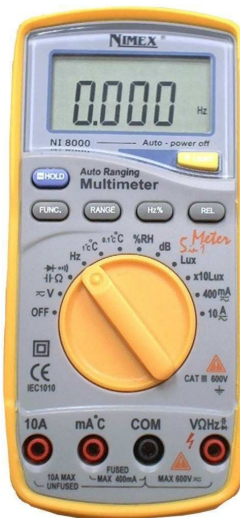

Multimeter digitalni autorange 4 digit NI 8000

SPLOŠNI PODATKI:

- * 14 merilnih območij: enosmerna napetost in tok, izmenična napetost in tok, upornost, preizkus diode, preizkus prevodnosti z internim piskačem, kapacitivnost, temperatura, frekvenca, duty cycle, % vlage, akustično jakost in svetilnost.

- * 39 merilnih dosegov
- * za delovanje potrebuje eno samo 9V baterijo

AVTOMATSKA ZBIRA
MERILNI DOSEGI:

VCA: 4-40-400-600V
VCC: 400m-4-40-400-600V
CC: 40m-400m-10A
CA: 40m-400m-10A
R: 400-4K-40K-400K-4M-40MOhm
C: 4n-40n-400n-4μ-40μF-200μF
f: 9,999 - 99,99 - 999,9Hz - 9,999K - 99,99K - 199,9K - >200KHz
t: -20°C do +1000°C
DUTY CYCLE: 0,1 do 99,9%
VLAGA: od 30 do 95%RH
AKUSTIČNA JAKOST: od 35 do 100dB
SVETILNOST: 4000 - 40000LUX

temperatura delovanja: od 0°C do +40°C
dimenzije: 158x78x39mm
teža: 260g
ohišje: pvc z gumi zaščito

Zelo izpopolnjen multimeter z maksimalnim odčitavanjem 3999 na displeju. Poleg klasičnih električnih merilnih dosegov, omogoča tudi celo vrsto okoljskih meritev. Ima že vgrajene senzore za temperaturo, vlago, akustično jakost in svetilnost. Ohišje instrumenta je prevlečeno z mehko gumo, tako da je manj občutljiv na udarce.

V kompletu spadajo še kvalitetne merilne veze, zunanja sonda za merjenje temperature do 1000°C, obložena torbica, baterija, navodila v slovenščini.

Garancija 12 mesecev.

koda pak. barva
I9/11000 1 bež

DIGITALNI TERMOMETER NI 650



Digitalni termometer s priloženo zunanjo sondo.

SPLOŠNI PODATKI:

enote: °celsius ali fahrenheit
merilno območje: -50°C do +750°C
-58°F do +1382°F
resolucija: 1°C
poraba: 14mW
zunanja sonda: termočlen
dimenzije: 125x72x27mm

Za delovanje potrebuje eno samo 9V baterijo.

Priložena navodila in temperaturna sonda.

koda pak.
I9/8715 1

AMPERMETER ZA IZMENIČNI TOK



Ampermeter za izmenični tok za na panel
klasa: 2,5
material: plexi odporen na udarce
zunanje dimenzije: 70x60mm

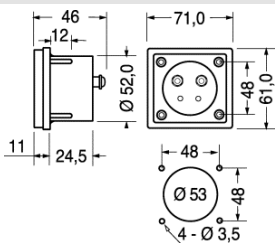

Koda	doseg	pak.
I9/1000	0 : 5A~	1
I9/1010	0 : 10A~	1
I9/1020	0 : 15A~	1
I9/1040	0 : 50A~	1

VOLTMETER ZA IZMENIČNO NAPETOST



Voltmeter za izmenično napetost za na panel
klasa: 2,5
material: plexi odporen na udarce
zunanje dimenzije: 70x60mm

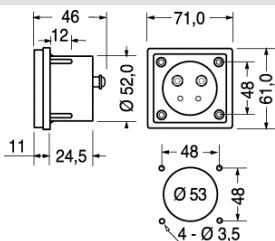

Koda	doseg	pak.
I9/1240	0 : 300V~	1
I9/1250	0 : 500V~	1

VOLTMETER ZA ENOSMerno NAPETOST



Voltmeter za enosmerno napetost za na panel
klasa: 2
material: plexi odporen na udarce
zunanje dimenzije: 70x60mm

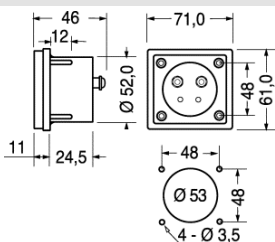

Koda	doseg	pak.
I9/1410	0 : 15V=	1
I9/1420	0 : 30V=	1

AMPERMETER ZA ENOSMERNI TOK



Ampermeter za enosmerni tok za na panel
klasa: 2
material: plexi odporen na udarce
zunanje dimenzije: 70x60mm

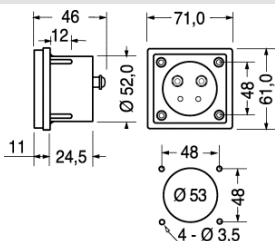

Koda	doseg	pak.
I9/1610	0 : 5A=	1
I9/1620	0 : 10A=	1
I9/1630	0 : 15A=	1

VOLTMETER LCD



Voltmeter LCD za enosmerno napetost za na panel

Nastavljivo merilno območje: 20VDC in 200VDC
maksim. prikazovanje: 1999
Z ustreznimi dodanimi upori je možno spremeniti merilne dosege, območja in vejico.
notranja upornost: >100MΩ
napajanje: 8 do 15V
natančnost: ± 0,5%
poraba: 1mA

koda pak.

I9/2050	1
---------	---

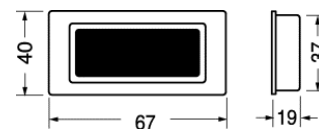

VEZE ZA MULTIMETER



Veze za merilni instrument

izpolnjujejo norme IEC1010
črna in rdeča veza
dolžina: 70cm
vtičaka banana kotni fi 4mm

koda pak.

I4/3673	1 par
---------	-------

VEZE ZA MULTIMETER



Veze za merilni instrument professional

izpolnjujejo norme IEC1010 in ISO 2002
dolžina: 1m
nosilnost: 10A
premer kabla 1mmq
stikalna upornost: 20mOhm
za instrumente kot so; FLUKE, METRIX, SANWA, NIMEX,...

koda pak.

I4/3698	1 par
---------	-------

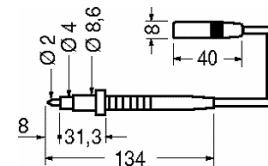

TIPALA ZA MULTIMETER



Veze za multimeter

* kontakti v obliki klešč
* vtičnica banana fi 4mm
* ohišje: bakelit / vinil
* nosilnost: 6A 1000V
* upornost kontaktov: <50mOhm

koda pak. barva

I4/3684	1	rdeča
I4/3686	1	črna

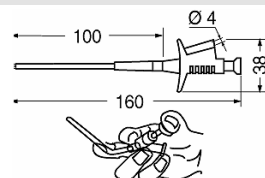

ŽARNICA BAJONET P13,5S

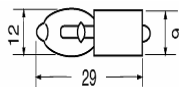

Žarnica bajonet P13,5S za baterijske svetilke

okov: P13,5S

Primerna kot zamenjava za prenosne baterijske svetilke. Žarnica kripton daje 70% več svetlobe od obične žarnice!

koda	V	A	pakirano kos	opomba
Ž4/7880A	2,4V	0,7A	25	kripton
Ž4/7890A	2,5V	0,5A	25	
Ž4/7890B	3,6V	0,5A	25	
Ž4/7890C	3,6V	0,7A	25	kripton
Ž4/7891	3,6V	0,5A	25	
Ž4/7892	4,8V	0,5A	25	
Ž4/7893	6V	0,5A	25	
Ž4/7894	7,2V	0,5A	25	

ŽARNICA KROGLA E10



Fžarnica krogla E10

okov: E10

Primerna kot zamenjava za prenosne baterijske svetilke in signalne žarnice.

koda	V	A	pak. kos	opomba
Ž4/8037A	2,5V	0,2A	25	
Ž4/8037B	3,5V	0,2A	25	
Ž4/8039	4,8V	0,3A	25	
Ž4/8040	6,3V	0,15A	25	signalna 1W
Ž4/8041	12V	0,25A	25	
Ž4/8045	6V	0,5A	25	utripajoča za kolesa
Ž4/8055	6V	0,5A	25	
Ž4/8056A	24V	0,125A	25	
Ž4/8056B	24V	0,08A	25	signalna 2W

ŽARNICA E10 Z LEČO

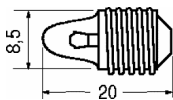

Žarnica E10 z lečo

okov: E10

Primerna kot zamenjava za prenosne baterijske svetilke.

koda	V	A	pakirano kos
Ž4/8026	1,1V	0,2A	25
Ž4/8026A	1,2V	0,22A	25
Ž4/8026B	2,2V	0,2A	25
Ž4/8027A	3,5V	0,2A	25
Ž4/8028A	3,8V	0,2A	25

TLIVKA 220V~



Tlilka 220V E10

okov: E10

Primerna kot signalna žarnica.

koda	V	pakirano kos
Ž4/8030	220	25

HALOGEN ŽARNICA BAJONET P13,5S

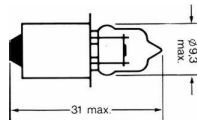

Halogen žarnica bajonet

okov: P13,5S

Primerna kot zamenjava za prenosne baterijske svetilke.

koda	V	A	pakirano kos	življenska doba cca
Ž58720	2,8V	0,85A	1	10 h
Ž58760	5,2V	0,85A	1	10h
Ž58780	6V	0,85A	1	10 h

SIGNALNA ŽARNICA T1 1/2

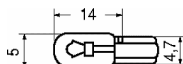

Signalna žarnica T1 1/2

okov: T1 1/2

Primerna kot signalna žarnica.

koda	V	A	pakirano kos	življenska doba cca
Ž4/7852	12V	80mA	25	1000 h
Ž4/7854	24V	40mA	25	1000 h

ŽARNICA Ba9s

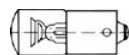

Žarnica z nitko

okov: Ba9s

koda	V	dimenzija	pakirano kos
ŽBA912	12V	10x28mm	10
ŽBA924	24V	10x28mm	10

ŽARNICA ZA TELEFON T5,5

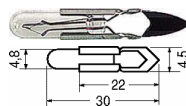

Žarnica za telefon

okov: T5,5

koda	V	A	pakirano kos	življenska doba cca
Ž4/7932	12V	50mA	10	2000 h

ŽARNICA HALOGEN E10



Žarnica halogen E10

okov: E10

koda	V	A	pakirano kos	življenska doba cca
Ž4/7869A	4V	0,85A	1	10 h

TLIVKA 220V~



Tlilka 220V

dimenzije: 6x28mm

Primerna kot signalna žarnica ob tipki za zvonec, v domofonih,.....

koda	V	pakirano kos
ŽS104	220V	10

ŽARNICA HALOGEN



Žarnica halogen
2 pin

okov: G4 in GY6,35
°Kelvin: 3000
Povprečna življenska doba je 2.000 ur!
Izdelane po standardu ISO 9001.

koda	V	W	okov	Lumen	pak. kos
ŽH12V10W	12V	10W	G4	140	10
ŽH12V20W	12V	20W	G4	350	10
ŽH12V35W	12V	35W	GY6,35	625	10
ŽH12V50W	12V	50W	GY6,35	950	10
ŽH12V75W	12V	75W	GY6,35	1350	10

ŽARNICA HALOGEN DIKROIDNA



Žarnica halogen dikroidna
MR16 Ø50mm

okov: GU5,3
°Kelvin: 3000
Brez stekla.
Povprečna življenska doba je 2.500 ur!
Izdelane po standardu ISO 9001.

koda	V	W	okov	sevalni kot	pak. kos
ŽHD12V20W	12V	20W	GU5,3	36°	10
ŽHD12V35W	12V	35W	GU5,3	38°	10
ŽHD12V50W	12V	50W	GU5,3	24°	10

ŽARNICA HALOGEN DIKROIDNA



Žarnica halogen dikroidna
mala MR11 Ø35mm

okov: GU4
°Kelvin: 3000
Brez stekla.
Povprečna življenska doba je 2.500 ur!
Izdelane po standardu ISO 9001.

koda	V	W	okov	sevalni kot	pak. kos
ŽHDM12V20W	12V	20W	GU4	36°	10

ŽARNICA Z NITKO



Žarnice z nitko

okov: E14, Ba15d (bajonet)
moč: 15W
Primerne za hladilnike, pečice, šivalne stroje, signalne lučke,...

koda	V	W	okov	namenjena za	pak. kos
Ž600	230	15	E14	hladilnik	10
Ž605	230	15	E14	pečico	10
Ž607	230	15	Ba15d	šivalni stroj	10

UNO elektronika d.o.o.
Dolenja vas 1b 6224 Senožeče,
tel. 05 76-56-140 fax. 05 76-56-141

ŽARNICA HALOGEN LINEAR



Žarnica halogen linear

okov: R7s **pozlačen**
napetost: 220/240V
°Kelvin: 3000
Povprečna življenska doba je 2.000 ur!
Izdelane po standardu ISO 9001.

koda	W	dimenzije	Lumen	pak. kos
ŽHLK100W	100W	8x78mm	1400	10
ŽHLK150W	150W	8x78mm	2400	10
ŽHLD100W	100W	8x118mm	1400	10
ŽHLD150W	150W	8x118mm	2200	10
ŽHLD200W	200W	8x118mm	3200	10
ŽHLD250W	250W	8x118mm	4250	10
ŽHLD300W	300W	8x118mm	5000	10
ŽHLD500W	500W	8x118mm	9500	10
ŽHLK1000W	1000W	10x189mm	22000	5
ŽHLD1500W	1500W	10x254mm	33000	5

ŽARNICA FLUORESCENTNA



Žarnica fluorescentna

okov: G5
svetloba: dnevna

koda	W	dolžina	pakirano kos
ŽTF4	4W	135mm	10
ŽTF6	6W	212mm	10
ŽTF8	8W	288mm	10
ŽTF13	13W	517mm	10

ŽARNICA FLUORESCENTNA G24d



Žarnica fluorescentna G24d

okov: G24d 2 pinski
svetloba: dnevna

koda	W	model	pakirano kos
Ž649	10W	G24d-1	10
Ž650	13W	G24d-1	10
Ž651	18W	G24d-2	10
Ž652	26W	G24d-3	10

ŽARNICA FLUORESCENTNA G24q



Žarnica fluorescentna G24q

okov: G24q 4 pinski
svetloba: dnevna

koda	W	model	pakirano kos
Ž6528	10W	G24q-1	10
Ž653	13W	G24q-1	10
Ž654	18W	G24q-2	10
Ž655	26W	G24q-3	10

SIGNALNA ŽARNICA VGRADNA

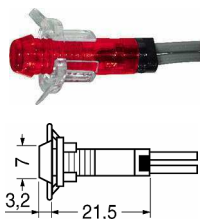

Signalna žarnica vgradna s kablom

napetost: 230V
Vgrajena žarnica: tlvika
dolžina kablov: 25cm
pritrnitev: s kontra matico

koda	V	pakirano kos	barva
Ž4/8220	230V	10	rdeča
Ž4/8221	230V	10	zelena

SIGNALNA ŽARNICA VGRADNA

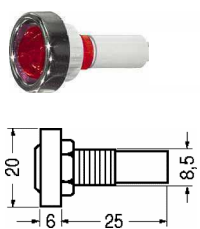

Signalna žarnica vgradna z matico, brez kabla

napetost: 230V
vgrajena žarnica: tlvika
kontakti: faston 6,3mm
pritrnitev: z matico
Primerna kot signalna žarnica za štedilnike, komandne pulte,....

koda	V	pakirano kos	barva
ŽS2233	230	10	rdeča

SIGNALNA ŽARNICA VGRADNA

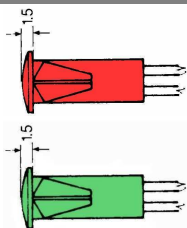

Signalna žarnica vgradna s kablom

napetost: 230V
vgrajena žarnica: tlvika
dolžina kablov: 25cm
pritrnitev: na pritisek
Primerna kot signalna žarnica za bojlerje, štedilnike, komandne pulte,....

koda	V	pakirano kos	barva
ŽS212	230	10	rdeča
ŽS212Z	230	10	zelena

LED DIODE

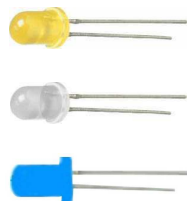

Led diode 3mm in 5mm v različnih barvah.

napajanje: po tabeli
nominalni tok: 20mA
za nosilce led diod Ø 5mm tipa Ž4/8152.

Za delovanje potrebuje zunanji upor! $R=(U-2) / 0,02$

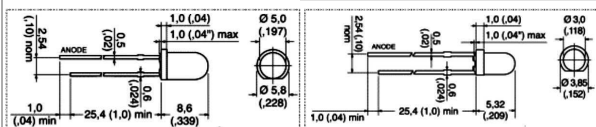

koda	Ø	barva	napaja.	mcd	pak
E19/4200	5mm	rdeča	2V	7	20
E19/4205	5mm	zelena	2,1V	15	20
E19/4210	5mm	rumena	2,1V	43	20
E19/4214	5mm	modra	4,7V	1500	10
E19/4300	5mm	rdeča	2V	2000	10
E19/4350	5mm	bela	3,6V	10000	10
E19/4100	3mm	rdeča	2V	1	20
E19/4105	3mm	zelena	2,1V	10	20
E19/4110	3mm	rumena	2V	12	20

NOSILEC SIGNALNE ŽARNICE

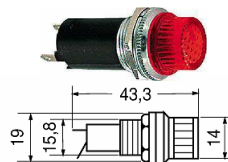

Nosilci signalne žarnice z okovom E10
okov: E10
barve: rdeča, zelena, prozorna
kontakti: na spajkanje
pritrnitev: z matico

koda	barva	pakirano kos	opomba
Ž4/8110	rdeča	10	brez žarnice
Ž4/8112	zelena	10	brez žarnice
Ž4/8114	prozorna	10	brez žarnice

OKOV ZA ŽARNICO E10

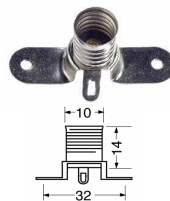

Okov za žarnico E10

okov: E10
za napetost: do 24V
ohišje: kovinsko
kontakti: na spajkanje
Okov pritrldimo z vijaki Ø3mm

koda	pakirano kos
Ž4/8121	10

OKOV ZA ŽARNICO E10

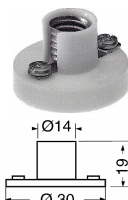

Okov za žarnico E10

okov: E10
za napetost: do 24V
kontakti: na vijak
ohišje: PVC
Odličnen za šolsko uporabo

koda	pakirano kos
Ž4/8126	10

NOSILEC LED DIODE 5mm

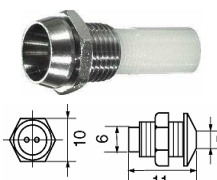

Nosilec led diode 5mm, z mestom za upor

Za led diode fi 5mm in upore od 1/4W.
ohišje: kovinsko - kromirano
Za led diode tipa E19/4200

koda	pakirano kos	opomba
Ž4/8152	10	brez led diode

NOSILEC LED DIODE 3mm

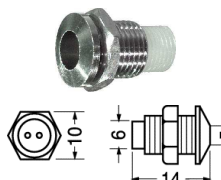

Nosilec led diode 3mm, z mestom za upor

Za led diode fi 3mm.

ohišje: kovinsko - kromirano
Za led diode tipa E19/4100

koda	pakirano kos	opomba
Ž4/8154	10	brez led diode

UNO elektronika d.o.o.

Dolenja vas 1b
6224 Senožeče

tel. 05 76-56-140

mail: uno.elektronika@siol.net

SIGNALNA SVETILKA ZA NA PANEL



Signalna svetilka za na panel z LED diodami

Število vgrajenih LED diod (od 8 do 15) se spreminja v odvisnosti od barve, tako da je svetilnost pri vseh barvah enaka. Popolnoma neobčutljiva na tresljaje in udarce!
Ø navoja: 22mm, dimenzije: 22x34mm
Ohišje iz poliamida, leča iz polikarbonata
zaščita: IP65
kontakti na vijak
napajanje: izmenično AC ali enosmerno DC napetost
življenska doba: >50.000 ur!
delovna temperatura: od -25 do +55°C
svetloba: enakomerno porazdeljena po celotni površini leče
svetilnost primerljiva s 4W žarnico (z nitko)

koda	barva	napetost	tok	pak.
ŽSL12V-R	rdeča	12V AC/DC	80mA	10
ŽSL12V-Z	zelena	12V AC/DC	20mA	10
ŽSL12V-RU	rumena	12V AC/DC	80mA	10
ŽSL12V-M	modra	12V AC/DC	20mA	10
ŽSL12V-B	bela	12V AC/DC	20mA	10
ŽSL24V-R	rdeča	24V AC/DC	80mA	10
ŽSL24V-Z	zelena	24V AC/DC	20mA	10
ŽSL24V-RU	rumena	24V AC/DC	80mA	10
ŽSL24V-M	modra	24V AC/DC	20mA	10
ŽSL24V-B	bela	24V AC/DC	20mA	10
ŽSL230V-R	rdeča	230V AC	20mA	10
ŽSL230V-Z	zelena	230V AC	20mA	10
ŽSL230V-RU	rumena	230V AC	20mA	10
ŽSL230V-M	modra	230V AC	20mA	10
ŽSL230V-B	bela	230V AC	20mA	10

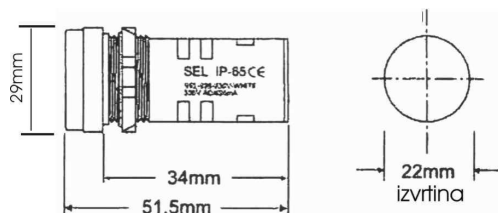

posebne izvedbe:				
ŽSLU24V	utripajoča rdeča	24V AC/DC	20mA	10
ŽSLUP24V	utripajoča rdeča + piskač	24V AC/DC + 80dB	30mA	10
ŽSLB24V	piskač	24V AC/DC +80dB	20mA	10

SIGNALNE ŽARNICE Z LED DIODO

Signalne žarnice z LED diodami

Popolnoma neobčutljive na tresljaje in udarce!
Življenska doba: >50.000 ur!
delovna temperatura: od -25 do +55°C

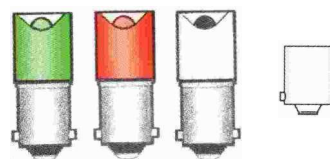

okov **Ba9s**

koda	barva	napetost	tok	pak.
ŽBA9220L-B	bela	220V AC	2mA	10
ŽBA9220L-R	rdeča	220V AC	2mA	10
ŽBA9220L-Z	zelena	220V AC	2 mA	10

SIGNALNE LUČKE Z LED DIODO



Signalne lučke z vgrajeno 5mm led diodo v različnih barvah.

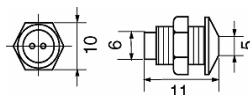

Nominalni tok: 20mA
2V led diode za delovanje potrebujejo upor!
12 in 24V led diode imajo že vgrajen upor!

koda	napajanje	barva	pak.
Ž4/8148R	2V	rdeča	10
Ž4/8148Z	2,1V	zelena	10
Ž4/8148RU	2,1V	rumena	10
Ž4/8148R-12V	9-12V	rdeča	10
Ž4/8148Z-12V	9-12V	zelena	10
Ž4/8148RU-12V	9-12V	rumena	10
Ž4/8148M-12V	9-12V	modra	10
Ž4/8148R-24V	15-24V	rdeča	10
Ž4/8148Z-24V	15-24V	zelena	10
Ž4/8148RU-24V	15-24V	rumena	10
Ž4/8148B-24V	15-24V	bela	10

SIGNALNE LUČKE Z LED DIODO



Signalne lučke Ø22mm, z vgrajeno 10mm led diodo v različnih barvah.

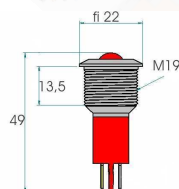

Delovna napetost:
24VAC (8mA)
24VDC (16mA)

Priključek: faston 2,8mm

koda	napajanje	barva	pak.
Ž4/8151R-24V	24VAC/DC	rdeča	1
Ž4/8151Z-24V	24VAC/DC	zelena	1
Ž4/8151RU-24V	24VAC/DC	rumena	1

UNO elektronika d.o.o.

Dolenja vas 1b
6224 Senožeče

**POVEZOVALNA VRVICA
ISO STANDARD**

Vtikač ISO standard za avtomobile VW, OPEL, AUDI, FIAT, LANCIA, ALFA, SEAT, ROVER,..... in druge.
vezava: napajanje + 4 zvočniki



koda pakiranje
V57039SDF 1

Vtičnici ISO standard za avtomobile VW, OPEL, AUDI, FIAT, LANCIA, ALFA, SEAT, ROVER,..... in druge.
vezava: napajanje + 4 zvočniki Pakirano v paru.



koda pakiranje
V59113/114 1

Povezovalna vrstica ISO za CITROEN, PEUGEOT, RENAULT, ...
vezava: napajanje + 4 zvočniki



koda pakiranje
V59092 1

**VRVICA ZA ZVOČNIKE
ZA RENAULT, VW,.....**

Povezovalna vrstica za zvočnike za PEUGEOT, ALFA, FIAT, LANCIA,



koda pakiranje pakirano po 1 par
V57049 1

PODALJŠEK ZA AVTOANTENO

Podaljšek za avtoanteno, vtičač / vtičnica



koda	dolžina	barva	pakiranje
VP070	0,7m	bela	1
VP200	2m	bela	1
VP350	3,5m	bela	1

**ANTENSKI ADAPTER
BOSCH NA KABLU**

Avto antenski adapter, med vtičačem BOSCH in obično antensko vtičnico, na kablu.

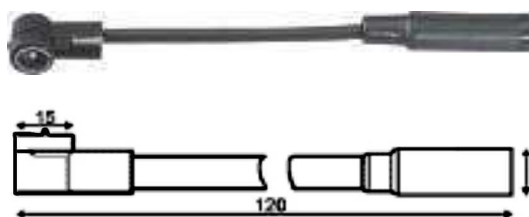

koda pakiranje
V57089 1

ANTENSKI ADAPTER BOSCH

Avto antenski adapter med vtičnico BOSCH in običnim avto antenskim vtičačem.



koda pakiranje
V57091 1

ANTENSKI AVTO KONEKTORJI

Vtikač za avtoanteno
kontakti: na spajkanje

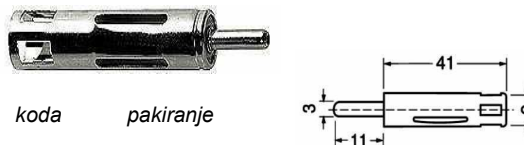

koda pakiranje
C8/2300 10

Vtičnica za avtoanteno
kontakti: na spajkanje

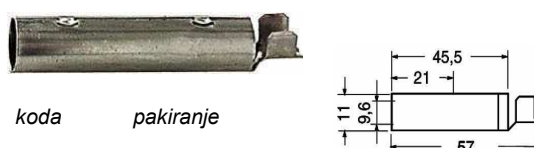

koda pakiranje
C8/2305 10

VTIKAČ ZA AVTOVŽIGALNIK



Vtikač za avtovžigalnik
tok: 20A 36V maks.
ohišje: makrolon
kontakti: na spajkanje

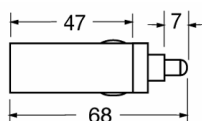

koda pakiranje
C8/1505 10

VTIČNICA ZA AVTOVŽIGALNIK



Vtičnica za avtovžigalnik
tok: 20A 36V maks.
ohišje: makrolon
kontakti: na spajkanje

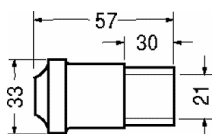

koda pakiranje
C8/1510 10

**VTIČNICA ZA AVTOVŽIGALNIK
VGRADNA**



Vtičnica za avtovžigalnik
vgradna
Tok: 20A 36V maks.
material: kovina in porcelan
kontakti: faston 6,3mm

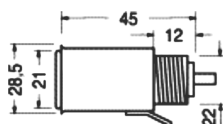

koda pakiranje
C8/1520 10



Vtičnica za avtovžigalnik
vgradna s PVC pokrovom
in kablom

Tok: 20A 36V maks.
material: kovina in PVC
kontakti: kabel L=30cm

koda pakiranje
C8/1515 1

PREMOSTITVENA SPONKA



Premostitvena sponka
tok: 20A 36V maks.
ohišje: pvc
kontakti: pokositrani, na
pritisk

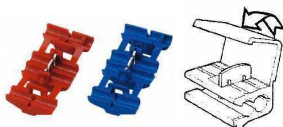

koda	pakiranje	barva	za premer kabla
CFA050	10	rdeča	1,5mm\varnothing
CFA051	10	modra	2,5mm\varnothing

NOSILEC NOŽASTIH VAROVALK

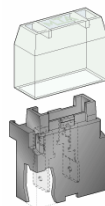

Nosilec nožastih varovalk
30A 36V
ohišje: ABS s pokrovčkom
kontakti: faston 6,3mm
Je možno sestaviti več
nosilcev skupaj

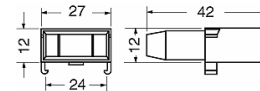

koda pakiranje
V517 1

NOSILEC VAROVALK 6x32mm

Nosilec steklenih varovalk 6x32mm na kablu.
tok: do 10A
napetost: do 32V



koda pakiranje
C4/10558 10

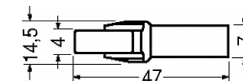

NOSILEC VAROVALK 5x20mm

Nosilec steklenih varovalk 5x20 mm brez kabla.
tok: do 16A
napetost: do 250V



koda pakiranje
M504 10

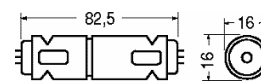

BLOKCI FASTON

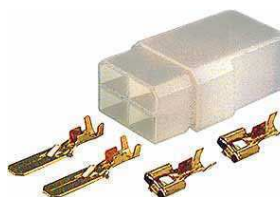

Blokec faston, komplet
vtikač + vtičnica + kabel
čevlji
tok: 20A 250V maks.
ohišje: pvc
kontakti: faston 6,3mm

koda	kontakti	pakiranje
CFA402	2	1
CFA404	4	1
CFA406	6	1
CFA408	8	1

UNO elektronika d.o.o.

**Dolenja vas 1b
6224 Senožeče**

mail: uno.elektronika@siol.net
www.unoelektronika.si

**KROKODIL IZOLIRAN IEC1010
10A 600V L=49mm**



Krokodil popolnoma izoliran po standardu IEC1010.
Nosilnost: 10A 600V
Material: polyamid L=49mm
Za veze fi 2mm koda I4/3673.

koda	pak.	barva
C4/3633	1	rdeča
C4/3635	1	črna

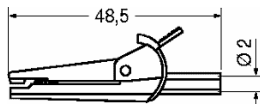

**KROKODIL
L=60mm**



Krokodil L=60mm.
Material: polistirol
Za veze ali banane fi 4mm.

koda	pak.	barva
C4/3624	10	rdeča
C4/3626	10	črna

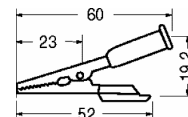

**KROKODIL IZOLIRAN IEC1010
20A 1000V L=90mm**



Krokodil popolnoma izoliran po standardu IEC1010.
Nosilnost: 20A 1000V
Material: polyamid L=90mm
Za veze ali banane fi 4mm.

koda	pak.	barva
C4/3621	1	rdeča
C4/3623	1	črna

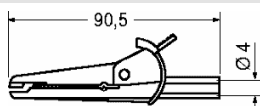

**KROKODIL 40A
L=80mm**



Krokodil 40A L=80mm
Nosilnost: 40A 12-24V
Priključitev kabla s spajkanjem ali z vijakom.
Za kable do 6mmq.

koda	pak.	barva
C4/3660	10	rdeča
C4/3662	10	črna

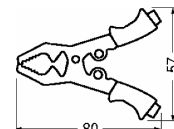

**KROKODIL IZOLIRAN
L=27mm**



Krokodil izoliran L=27mm.
Material: vinil
Za kable do 0,75mmq.
Priključitev kabla s spajkanjem.

koda	pak.	barva
C4/3644	10	rdeča
C4/3646	10	črna

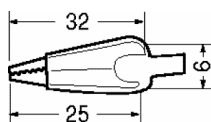

**KROKODIL 80A
L=125mm**



Krokodil 80A L=125mm
Nosilnost: 80A 12-24V
Priključitev kabla s spajkanjem ali z vijakom.
Za kable do 16mmq.

koda	pak.	barva
C4/3670	10	rdeča
C4/3672	10	črna

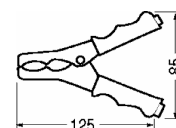

**KROKODIL IZOLIRAN
L=42mm**



Krokodil izoliran L=42mm.
Material: vinil
Za kable do 1,5mmq.
Priključitev kabla s spajkanjem.

koda	pak.	barva
C4/3648	10	rdeča
C4/3650	10	črna

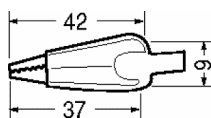

**KROKODIL 120A
L=180mm**



Krokodil 120A L=185mm
Nosilnost: 120A 12-24V
Priključitev kabla s spajkanjem ali z vijakom.
Za kable do 25mmq.

koda	pak.	barva
C4/3675A	2	rdeča
C4/3675B	2	črna

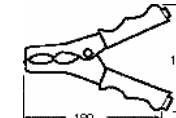

**KROKODIL IZOLIRAN
L=52mm**



Krokodil izoliran L=52mm.
Material: bakelit
Za veze ali banane fi 4mm.

koda	pak.	barva
C4/3652	10	rdeča
C4/3654	10	črna

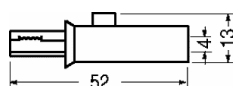

SET KROKODILOV Z VRVICO



Set krokodilov z vrstico (10 kosov).
Premer kabla: 0,15mm

koda	pak.	barva	dolžina
I4/3637	1	10 barv	460mm
I4/3638	1	10 barv	560mm

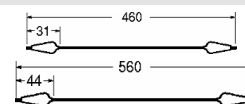

VAROVALKE 5x20mm HITRE "F"

Varovalka cevna 5x20mm hitra (FAST).

Material: steklo kontakti: niklana medenina
Delovna napetost: 250V
Za nosilce varovalk C4/10530, C4/10500, M504.
Pakirano po 10 kosov!



koda	amper	koda	amper
VM0.1	100mA F	VM2	2A F
VM0.125	125mA F	VM2.5	2,5A F
VM0.2	200mA F	VM3.15	3,15A F
VM0.25	250mA F	VM4	4A F
VM0.315	315mA F	VM5	5A F
VM0.4	400mA F	VM6.3	6,3A F
VM0.5	500mA F	VM8	8A F
VM0.63	630mA F	VM10	10A F
VM0.8	800mA F	VM12	12,5A F
VM1	1A F	VM16	16A F
VM1.25	1,25A F	VM20	20A F
VM1.6	1,6A F	VM25	25A F

VAROVALKE 6x32mm HITRE "F"

Varovalka cevna 6x32mm hitra (FAST).

Material: steklo kontakti: niklana medenina
Delovna napetost: 250V
Za nosilce varovalk C4/10540, C4/10558.
Pakirano po 10 kosov!



koda	amper	koda	amper
VV1	1A F	VV6.3	6,3A F
VV1.25	1,25A F	VV8	8A F
VV1.6	1,6A F	VV10	10A F
VV2	2A F	VV12	12,5A F
VV2.5	2,5A F	VV16	16A F
VV3.15	3,15A F	VV20	20A F
VV4	4A F	VV25	25A F
VV5	5A F		

VAROVALKE 5x20mm POČASNE "T"

Varovalka cevna 5x20mm počasna "T"

Material: steklo kontakti: niklana medenina
Delovna napetost: 250V
Za nosilce varovalk C4/10530, C4/10500, M504.
Pakirano po 10 kosov!



koda	amper	koda	amper
VMT0.2	0,2A T	VMT3.15	3,15A T
VMT0.5	0,5A T	VMT4	4A T
VMT0.63	0,63A T	VMT5	5A T
VMT1	1A T	VMT6.3A	6,3A T
VMT1.25	1,25A T	VMT10	10A T
VMT1.6	1,6A T	VMT12	12A T
VMT2	2A T	VMT16	16A T
VMT2.5	2,5A T	VMT20	20A T

VAROVALKE NOŽASTE ZA AVTO

Varovalka nožasta za avto.

Material: PVC kontakti: niklana medenina
Delovna napetost: 24V
Za nosilce varovalk V517 (slika na strani 16).
Pakirano po 10 kosov!



koda	amper	koda	amper
VA03	3A	VA15	15A
VA04	4A	VA20	20A
VA05	5A	VA25	25A
VA07.5	7,5A	VA30	30A
VA10	10A		

VAROVALKE NOŽASTE OZKE

Varovalka nožasta ozka.

Material: PVC
kontakti: niklana medenina
Delovna napetost: 24V
Pakirano po 10 kosov!

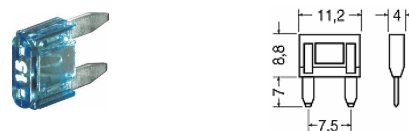

koda	amper	koda	amper
VAM02	2A	VAM07.5	7,5A
VAM03	3A	VAM10	10A
VAM04	4A	VAM15	15A
VAM05	5A		

TERMIČNE VAROVALKE

Termična varovalka " cut off ".

Delovna napetost in tok: 250V 12A.
Kontakti: na spajkanje, za tiskano vezje
Uporablja se kot zaščita napajalnih transformatorjev,
elektronskih komponent, grelnikov, bojlerjev,.....
Ko doseže delovno tempereturo se varovalka prekine.
Pakirano po 10 kosov!



koda	temperatura izklopa
VT104	104°C
VT117	117°C
VT128	128°C
VT216	216°C
VT229	229°C
VT240	240°C

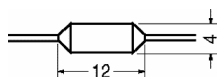

NOSILCI VAROVALK



C4/10500 C4/10530 C4/10540 C4/10558 M504

FASTON ŽENSKI



Faston ženski
material: medenina
kontakti: na krimpnanje
izolacije: CFA030,....
klešča za krimpnanje: O7/1849

koda dimenzija a za kable

CFA001	2,8mm	0,5-0,7mmq
CFA002	4,8mm	0,5-1,5mmq
CFA003	6,3mm	0,5-2,5mmq

(pakirano po 100 kosov)

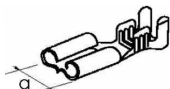

FASTON MOŠKI 6,3mm DOLGI

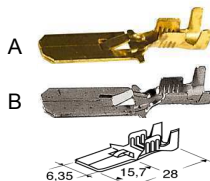

Faston moški 6,3mm dolgi z ježičkom (za blokce faston)
kontakti: na krimpnanje
klešča za krimpnanje: O7/1849

koda dimenzija material slika za kable

CFA024	6,3mm	medenina	A	1 - 2,5mmq
CFA025	6,3mm	kositrani baker	B	0,5-1,5mmq

(pakirano po 100 kosov)

FASTON MOŠKI



Faston moški
material: medenina
kontakti: na krimpnanje
klešča za krimpnanje: O7/1849

koda dimenzija a za kable

CFA020	2,8mm	0,5-0,7mmq
CFA021	4,8mm	0,5-1,5mmq
CFA022	6,3mm	0,5-2,5mmq

(pakirano po 100 kosov)

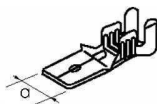

VOTLICA IZOLIRANA



Votlica izolirana
material: kositrani baker
klešča: O9039A

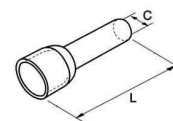

koda za presek kabla dolžine L pakirano

CFA452	0,5 mmq	8mm	500
CFA455	0,75 mmq	8mm	500
CFA460	1 mmq	8mm	500
CFA463	1,5 mmq	8mm	500
CFA466	2,5 mmq	8mm	250
CFA470	4 mmq	10mm	200
CFA475	6 mmq	10mm	100

FASTON ŽENSKI 6,3mm KOTNI



Faston ženski 6,3mm kotni
material: medenina
kontakti: na krimpnanje

koda dimenzija za kable

CFA005	6,3mm	0,25-1,2mmq
--------	-------	-------------

(pakirano po 100 kosov)

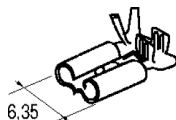

ČEVLJIČEK OČESNI



Čevljiček očesni
material: kositrani baker
klešča: O7/1851

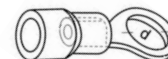

Koda luknja d barva za kabel pakiranje

CFA510	3,2mm	rdeča	1,5mmq	100
CFA511	4,3mm	rdeča	1,5mmq	100
CFA521	4,3mm	plava	2,5mmq	100
CFA523	6,5mm	plava	2,5mmq	100
CFA524	8,4mm	plava	2,5mmq	100
CFA534	8,4mm	rumena	4mmq	100

FASTON ŽENSKI 6,3 Z JEŽIČKOM



Faston ženski 6,3mm z ježičkom (za blokce faston)
kontakti: na krimpnanje
klešča za krimpnanje: O7/1849



koda dimenzija material slika za kable

CFA006	6,3mm	medenina	A	1 - 2,5mmq
CFA007	6,3mm	kositrani baker	B	0,5 - 1,5mmq

(pakirano po 100 kosov)

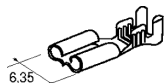

IZOLACIJA ZA FASTON

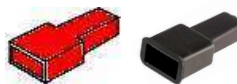

Izolacija za kebel čevlje faston
material: pvc
barve: črna, rdeča, prozorna

koda za kabel čevlji: pakirano po

CFA030	za vtičnico 2,8mm	50 rdečih + 50 črnih
CFA031	za vtičnico 4,8mm	50 rdečih + 50 črnih
CFA032	za vtičnico 6,3mm	50 rdečih + 50 črnih
CFA032P	za vtičnico 6,3mm	100 prozornih
CFA033	za vtičnik 6,3mm	50 rdečih + 50 črnih

FASTON ŽENSKI 9,5mm ŠIROKI



Faston ženski 9,5mm široki
material: medenina
kontakti: na krimpnanje
klešča za krimpnanje: O7/1849

koda dimenzija za kable

CFA004	9,5mm	2 - 4mmq
--------	-------	----------

(pakirano po 100 kosov)

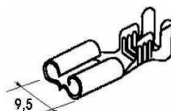

**KLEŠČA ZA REZANJE
BAKRENE ŽICE TR-5000R**

Klešča za rezanje bakrene žice do max. fi 1,6mm.
Za uporabo v elektrotehničnem področju.
Zelo precizne! Ročaji so oblečeni v mehki PVC.

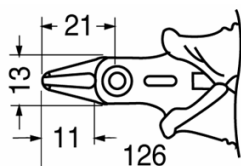

koda pakiranje
O7/1800 1 kos v blisterju

**KLEŠČA ZA REZANJE
BAKRENE ŽICE TR-25P**

Klešča za rezanje bakrene žice do max. fi 1mm.
Za uporabo v elektrotehničnem področju.
Zelo precizne! Ročaji so oblečeni v mehki PVC.

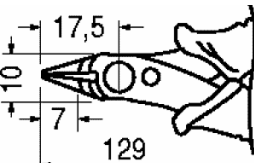

koda pakiranje
O7/1820 1 kos v blisterju

**KLEŠČA ZA REZANJE
BAKRENE ŽICE TR-30**

Klešča za rezanje bakrene žice do max. fi 1,3mm.
Za uporabo v elektrotehničnem področju.
Zelo precizne! Ročaji so oblečeni v mehki PVC.

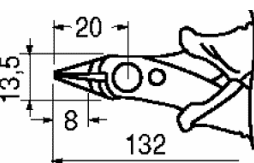

koda pakiranje
O7/1822 1 kos v blisterju

PINCETE

Pincete iz nerjavečega materiala
Za uporabo v elektrotehničnem področju.
Zelo precizne!
Zaščitene proti kislini. Nemagnetne.



koda	pak.	konice	dolžina
O7/1505	1	ozke in ploščate	110mm
O7/1512	1	širše in ploščate	160mm

**KLEŠČA ZA KRIMPANJE
KABEL ČEVLJE IN KONČNIKE**

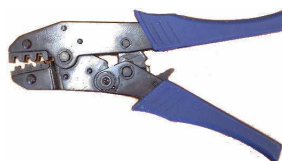

Klešča za krimpnanje:
kabel čevlje, končnike,
tulce, ...
Nastavljiva moč stiskanja.

koda	pak.	namenjene za krimpnanje:
O7/1849	1	gole kabel čevlje od 0,5 do 6mmq
O7/1851	1	izolirane kabel čevlje od 1,5 do 6mmq
O9039A	1	končnikov - tulcev od 0,5 do 6mmq

**KLEŠČA ZA KRIMPANJE
RG KONEKTORJEV**

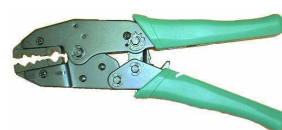

Klešča za krimpnanje RG
konektorjev.
Za kable: RG58, RG59, RG62,
RG174, RG223, RG316, RG6.

koda	pakiranje
O7/1876	1

KLEŠČA ZA SNEMANJE IZOLACIJE



Klešča za snemanje
izolacije od vodnikov.
Za kable preseka 0,5 do
6mm².

koda	pakiranje
O7/1854	1

KLEŠČA ZA ZATEGOVANJE VEZIC



Klešča za zategovanje
vezic.
Za vezice širine 2,2 do
4,8mm.
Avtomatsko zateguje in reže
vezico.

koda	pakiranje
O5401	1



**KLEŠČA ZA STISKANJE VOTLIC
IN KONČNIKOV**

Klešča za štirioglasto stiskanje votlic in končnikov
Za kable preseka 0.08 do 6mm²



koda pakiranje
O7/18524 1 kos v blistru

Klešča za šestoglasto stiskanje votlic in končnikov
Za kable preseka 0.08 do 6mm²



koda pakiranje
O7/18526 1 kos v blistru

STOPNIČASTI SFEDRI

Stopničasti sfedri RUKO za vrtnanje do debeline 2mm v
pločevino, bakrene plošče, aluminijaste plošče in
plastiko .
V kompletu 3 HSS sfedri



sveder	premer v mm
1	od 4 do 12mm vsak mm
2	od 4 do 20mm vsaka 2 mm
3	od 4 do 30mm vsaka 2 mm

koda pakiranje
O7/1900B 1 kos v škatli

KONTAKT SPRAY



Kontakt spray 200ml.

Čisti in podmazuje kontakte,
odstranjuje oksid, povečuje
prevodnost.
Ni koroziven in ne poškoduje
elektronske komponente.
Za uporabo v elektroniki.

Vsebina 200ml.

koda pakiranje
O02 1

V IZDELAVI

V IZDELAVI



IZOLIRNI PVC TRAKOVI No.2133

IZOLIRNI TRAK 15mmx0,15mmx10m

Izolirni PVC trakovi **No.2133** širine 15mm, debeline 0,15mm, dolžine 10m, v pakiranju po 10 kosov.



koda	širina traku	dolžina	barva	pak.	škatla
OZ15B	15mm	10m	bela	10	200
OZ15Č	15mm	10m	črna	10	200
OZ15PL	15mm	10m	plava	10	200
OZ15RD	15mm	10m	rdeča	10	200
OZ15RJ	15mm	10m	rjava	10	200
OZ15RZ	15mm	10m	rum/zele	10	200
OZ15SI	15mm	10m	siva	10	200

IZOLIRNI TRAK 19mmx0,15mmx25m

Izolirni PVC trakovi **No.2133** širine 19mm, debeline 0,15mm, dolžine 25m, v pakiranju po 10 kosov.



koda	širina traku	dolžina	barva	pak.	škatla
OZ19B	19mm	25m	bela	10	120
OZ19Č	19mm	25m	črna	10	120
OZ19PL	19mm	25m	plava	10	120
OZ19RD	19mm	25m	rdeča	10	120
OZ19RJ	19mm	25m	rjava	10	120
OZ19RZ	19mm	25m	rum/zele	10	120
OZ19SI	19mm	25m	siva	10	120

IZOLIRNI TRAK 25mmx0,15mmx25m

Izolirni PVC trakovi **No.2133** širine 25mm, debeline 0,15mm, dolžine 25m, v pakiranju po 10 kosov.



koda	širina traku	dolžina	barva	pak.	škatla
OZ25B	25mm	25m	bela	8	96
OZ25Č	25mm	25m	črna	8	96
OZ25SI	25mm	25m	siva	8	96

UNO elektronika d.o.o.

Dolenja vas 1b
6224 Senožeče

tel. 05 76-56-140

fax. 05 76-56-141

www.unoelektronika.si

e-mail: uno.elektronika@siol.net

Področje uporabe izorimih trakov je zelo širok. V prvi vrsti se uporabljajo za izolacijo, spajanje in označevanje električnih kablov, tesnenje in krepitev spojev.

Izolirni trak **No.2133** ima odlične mehanske in električne lastnosti. Narejen je iz posebno trajnega samogasnega PVC filma in močne samovezne plasti, odporen proti staranju in temperaturnim spremembam. Certificiran za električne namene in klasificiran po standardu IEC 60454-3-16/F-PVC/p/90. Atestiran po standardu IMQ in BS. Uporaben za notranje in zunanje aplikacije.

**ŠIROKI IZOLIRNI TRAK
38mmx0,15mmx25m**

Široki izolirni PVC trak **No.2133** širine 38mm, debeline 0,15mm, dolžine 25m, v pakiranju po 10 kosov.



koda	širina traku	dolžina	barva	pak.	škatla
OZ38Č	38mm	25m	črna	10	60

**DEBELOSTENSKI IZOLIRNI TRAK
19mmx0,18mmx20m**

Debelostenski izolirni PVC trak **No.2133** širine 19mm, debeline 0,18mm, dolžine 20m, v pakiranju po 10 kosov.



koda	širina traku	dolžina	barva	pak.	škatla
OZ19X0.18Č	19mm	20m	črna	10	96

**SAMOSTOPLJIVI /
VULKANIZACIJSKI IZOLIRNI TRAK**

Debelostenski samostopljivi / vulkanizacijski izolirni trak. **N.62.2** širine 19mm, debeline 0,75mm, dolžine 9m



koda	širina traku	dolžina	barva	pak.	škatla
OZ19X9	19mm	9m	črna	10	48

OBJEMKE Z ŽEBLJIČKOM



Objemka z žebličkom.

Material: PVC

Žebliček: jeklen in pocinkan.

Barva: bela

koda	za Ø kabla	barva	namen
KOBZ04	3 do 4mm	bela	za telefonski kabel
KOBZ05	4 do 5mm	bela	za UTP kabel
KOBZ06	5 do 6mm	bela	za antenski kabel
KOBZ07	6 do 7mm	bela	PPL 3x0,75
KOBZ08	7 do 8mm	bela	PPL3x1,5
KOBZ10	9 do 10mm	bela	PPL3x2,5
KOBZ12	12 do 13mm	bela	PPL5x1,5

OBJEMKE Z ŽEBLJIČKOM



Objemka z žebličkom za telefonski ploščat kabel.

Material: PVC

Žebliček: jeklen in pocinkan.

Barva: bela

Pakirano po 100 kosov.

koda	za kabel širine	barva	namen
KOBZ06PL	od 4 do 5mm	bela	za telefonski ploščati kabel

V IZDELAVI



TERMOSKRČLJIVE CEVI 2:1

Termoskrčljiva cev črne barve.

Material: poliolefina

Skrčljivost: 2 : 1 (50%)

Delovna temperatura: od - 55°C do +125°C

Temperatura krčenja: +90°C

Izolativnost: >20KV/mm

Druge barve dobavljive po naročilu!

Prodaja se v kolutu ali po tekočem metru.

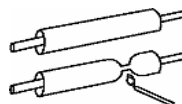

koda	notranji premer	debelina stene	pakiranje
KS01.2	1,2mm	0,33mm	kolut 150m
KS01.6	1,6mm	0,36mm	kolut 150m
KS02.4	2,4mm	0,44mm	kolut 150m
KS03.2	3,2mm	0,44mm	kolut 150m
KS04.8	4,8mm	0,56mm	kolut 150m
KS06.4	6,4mm	0,56mm	kolut 75m
KS09.5	9,5mm	0,56mm	kolut 75m
KS12.7	12,7mm	0,65mm	kolut 50m
KS19.1	19,1mm	0,80mm	kolut 30m
KS25.4	25,4mm	0,90mm	kolut 30m
KS32	31,8mm	0,90mm	kolut 30m
KS38	38,1mm	1,02mm	kolut 30m
KS50	50,8mm	1,02mm	kolut 30m
KS76	76,2mm	1,20mm	kolut 15m
KS102	101,6mm	1,30mm	kolut 12m

BUŽIRKE PVC

Bužirka PVC črne barve.

Uporablja se za zaščito električnih kablov v industrijskih omarah, avtomobilih, računalnikih, strojih,....

Je termoformirana v obliki napihnjene cevke, za lažje vstavljanje kablov

V črni barvi, ostale barve po naročilu.

Material: PVC 70

Delovna temperatura: od -15°C do +70°C, za kratek čas do +150°C

Izolativnost: >15KV/mm

Pakirano v kolutih



koda	notranji premer	debelina stene	pakiranje
KSC04	4mm	0,3mm	kolut 200m
KSC05	5mm	0,4mm	kolut 200m
KSC06	6mm	0,4mm	kolut 200m
KSC07	7mm	0,4mm	kolut 200m
KSC08	8mm	0,4mm	kolut 200m
KSC10	10mm	0,5mm	kolut 200m
KSC13	13mm	0,6mm	kolut 100m
KSC14	14mm	0,6mm	kolut 100m

SPAJKALA 25W, 40W, 60W

Spajkalo za cin z ozko konico

Napajanje: 230V.
Ročaj: PVC Konica: konusna, niklan baker
Dolžina napajalnega kabla s shuko vtičakem: 1,5m.
Rezervne konice serije S7/694



koda	moč	pakiranje
S7/650	25W	1
S7/652	40W	1
S7/653	60W	1



SPAJKALO NA PLIN PORTASOL

Spajkalo na plin

Ohišje: PVC Nastavljiva moč med 10 in 60W.
Maks. temperatura 440°C. Dimenzije: 175 x 19mm
Polnjenje: plin za vžigalnike. Ima vgrajen kremenčkov kamen za vžig. Čas spajkanja z enim polnjenjem do 1h.
Rezervna konica: S7/607



koda	moč	pakiranje
S7/600	10 do 60W	1



SPAJKALO ERS A 25W

Spajkalo za cin ERS A MULTITIP 25W

Napajanje: 230V
Čas segrevanja: 60"
Temperatura konice: 450°C
Konica: konusna, ERSADUR long life
Rezervne konice serija S7/20150



koda	moč	pakiranje
S7/10038	25W	1



SPAJKALO ERS A 40W

Spajkalo za cin ERS A SERIES 30 40W

Napajanje: 230V
Čas segrevanja: 120"
Temperatura konice: 420°C
Konica: ploščata, ERSADUR long life



koda	moč	pakiranje
S7/10131	40W	1



SPAJKALO PIŠTOLA 100W



Spajkalo pištola 100W.

Napajanje: 230V.
Ohišje: PVC
Konica: niklan baker.
Čas segrevanja: 3"
Ima vgrajeno stikalo in luč.
Rezervna konica: S7/559

koda	moč	pakiranje
S7/557	100W	1



SPAJKALO NA PLIN PORTASOL PIEZO SUPERPRO

Spajkalo na plin PORTASOL SUPERPRO piezo

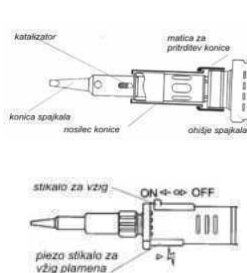

Ohišje: PVC
Rezervoar: jeklo inox
Nastavljiva moč: 25 - 125W
Maks. temperatura 580°C
Dimenzije: 230 x 25mm
Polnjenje: plin za vžigalnike
Ima vgrajen piezo mehanizem za vžig.
Čas spajkanja z enim polnjenjem: do 2 uri
Širok izbor konic serije S7/625

koda	moč	pakiranje
S7/615	25 do 125W	1



SPAJKALNA POSTAJA ERS A 80W

Spajkalo z digitalno regulacijo temperature ERS A RDS 80

Napajanje baze: 230V Napajanje spajkalne ročice: 24V
Moč spajkala: 80W Nastavljiva temp.: 150-450°C
Čas segrevanja: 40" Konica: ERSADUR long-life
Rezervne konice serije S7/20890



koda	moč	pakiranje
S7/15060	80W	1



ODSPAJKALNA POSTAJA ERS A

Odspajkalna enota ERS A CU 100 A + spajkalna enota ERS A DIGITAL 2000 A

Odspajkalna enota / kompresor: napajanje 230V
Moč kompresorja: 45W
Odspajkalna ročica: X TOOL 24V 120W (350°C)

Spajkalna enota: napajanje 230V 80W
Spajkalo: MICRO TOOL 24V 80W
Konica: ERSADUR long-life Čas segrevanja: 50"



koda	opis	pakiranje
S7/15125	odspajkalna enota CU 100 A	1
S7/15140	spajkalna enota DIGITAL 2000A	1

NAMIZNI NASTAVEK ZA SPAJKALO



Univerzalni namizni nastavek za spajkalo.

Za spajkala debeline do fi 16mm.
V kompletu spada še negorljiva gobica za čiščenje

koda	pakiranje
S7/1401	1

PREIZKUSNA PLOŠČICA

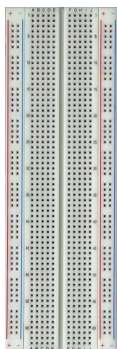

Preizkusna ploščica za elektroniko z 830 kontakti, dimenzije 55x165mm.

63 kontaktov na 10 linijah + 50 kontaktov na 4 linijah = 830
Material: ABS
Samolepljiva + oklopna folija.
Kontakti: posrebreni, upornost 10mΩ, kapacitivnost 10pF
Nosilnost kontaktov: 1A
Za nogice komponent debeline med 0,3 in 0,8mm.
Možnost sestavljanja več ploščic skupaj.

Koda	pak
S7/7060	1

NAMIZNI NOSILEC KOLUTOV CINA

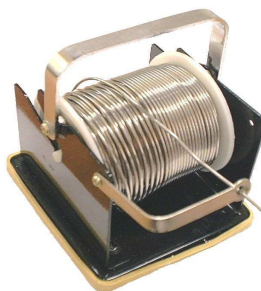

Namizni nosilec kolotov cina.

Za kolote cina težke od 500 do 1000gr, širine 70mm in premera 70mm.
Dimenzije: 100x90x110mm
Baza nosilca je obtežena in prevlečena z gumo. Na prednji strani ima vodilo za cin žico.

Koda	pakiranje
S7/1403B	1 kos

ČISTILNA GOBICA ZA SPAJKALO



Čistilna gobica za spajkalo.

Material: sintetična goba.
Dimenzije: 70 x 50mm.

koda	pakiranje
XW 5 22 419 99	1

CIN S TINOLOM PAKIRAN



Cin s tinolom pakiran fi 1,5mm 50gr.

Ohišje iz PVC.
Cin: Sn/Pb 60/40

koda	debelina cina	teža	pakiranje
ST1.5 050	1,5mm	50gr	25 kos

CIN S TINOLOM



Cin s tinolom.

Cin je navit na kolutu.

Cin: Sn/Pb 60/40

koda	debelina cina	teža	pakiranje
ST0.5 500	0,5mm	500gr	1 kos
ST0.8 500	0,8mm	500gr	1 kos
ST1 500	1mm	500gr	1 kos
ST1.5 500	1,5mm	500gr	1 kos
St1.5 1000	1,5mm	1000gr	1 kos

TINOL PASTA



Tinol pasta za elektroniko

Uporablja se pred spajkanjem, za čiščenje oksidirane površine.

koda	teža	pakiranje
S7/151	60gr	1

VAKUMSKI SESALEC CINA

Vakumski sesalec cinastandard.
Ohišje iz aluminija, konica iz teflona.
Dimenzija: 20 x 195mm.



koda pakiranje
S7/801 1

Vakumski sesalec cina maxi
Ohišje iz PVC, konica iz teflona.
Dimenzija: 26 x 220mm



koda pakiranje
S7/803 1

KONICE ZA SPAJKALO ERSA

Material konice: nikelj.
Za spajkala ERSA: S7/15000, S7/10035, S7/15070

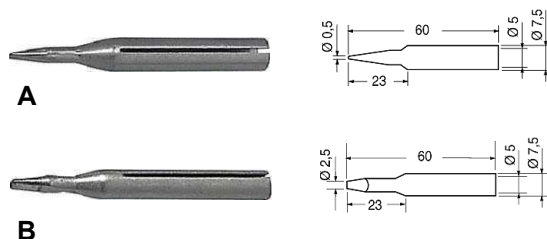

Koda	slika	Ø konice	pakiranje	material
S7/20160	A	0,4mm	1 kos	ersadur
S7/20180	B	2,5mm	1 kos	ersadur

KONICE ZA SPAJKALO

Material konice: niklan baker
Za spajkala : S7/650, S7/652, S7/653

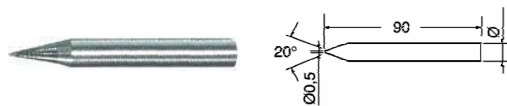

Koda	Ø konice	za spajkalo	pakiranje
S7/694	3,8mm	25W	1 kos
S7/698	4,8mm	40W	1 kos
S7/699	5,8mm	60W	1 kos

Material konice: niklan baker
Za spajkalo pištola S7/557



Koda	za spajkalo	pakiranje
S7/559	100W pištola	1 kos

KONICE ZA SPAJKALO NA PLIN PORTASOL PIEZO SUPERPRO

Material konice: niklan baker z vgrajeno komoro za izgorevanje. Za plinsko spajkalo S7/615.

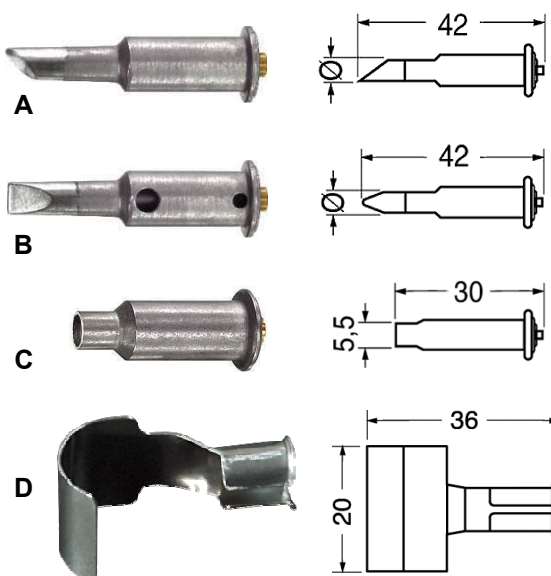

Koda	oznaka	slika	Ø konice	pakiranje
S7/625	SPT-1	A	1mm	1 kos
S7/626	SPT-2	A	2,4mm	1 kos
S7/630	SPT-5	B	1mm	1 kos
S7/631	SPT-6	B	2,4mm	1 kos
S7/632	SPT-7	B	3,2mm	1 kos
S7/635	SPT-9	C	puhavnik za vroči zrak	1 kos
S7/22145	SPT-12	D	deflektor za vroči zrak	1 kos

KONICE ZA SPAJKALO NA PLIN PORTASOL

Material konice: niklan baker z vgrajeno komoro za izgorevanje plina. Za plinsko spajkalo S7/600.



Koda	Ø konice	pakiranje
S7/607	2,4mm	1 kos

KONICE ZA SPAJKALO ERSA

Material konice: ERSA DUR
Za spajkala BASIC TOOL 80, 60, MULTI PRO

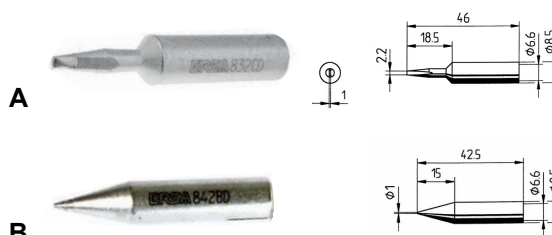

Koda	slika	konica	pakiranje	material
S7/20920	A	širine 2,2mm	1 kos	ersadur
S7/20991	B	Ø 1mm	1 kos	ersadur

VENTILATOR 40x40x10mm

Ventilator aksialni 40x40x10mm
z ležaji

Loputa: poliester
Drсни kontakti: ležaji
Šum: 28dB
Delovna temperatura: -20°C +80°C

Pakirano po 1 kos.

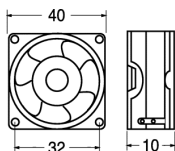

Koda	napetost	moč	obrati/min
M45/9572	5V DC	1,15W	6500

VENTILATOR 80x80x25mm

Ventilator aksialni 80x80x25mm.

Loputa: poliester
Drсни kontakti: puša
Šum: 32dB
Delovna temperatura: -10°C +70°C
Mrežica za ventilator: M45/9650 in M45/9670

Pakirano po 1 kos.

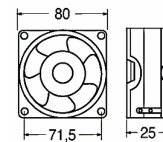

koda	napetost	moč	obrati/min
M45/9594	12V DC	2,4W	3100
M45/9594B*	12V DC	0,6W	1500
M45/9596	24V DC	3,1W	3100
M45/9600	220V AC	13W	2800

* priključek na kablju s 3 polnim konektorjem. Senzor vrtenja.

VENTILATOR 50x50x10mm

Ventilator aksialni 50x50x10mm
z ležaji in senzorjem vrtenja

Loputa: poliester
Drсни kontakti: ležaji
Šum: 30dB
Delovna temperatura: -20°C +80°C
Priključek na kablju s 3 polnim konektorjem

Pakirano po 1 kos.

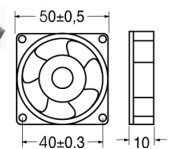
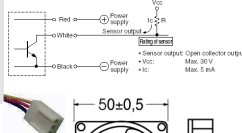

koda	napetost	moč	obrati/min
M45/9587B	12V DC	1,32W	4000

VENTILATOR 92x92x25mm

Ventilator aksialni 92x92x25mm.

Loputa: poliester
Drсни kontakti: puša
Šum: 32dB
Delovna temperatura: -10°C +70°C
Mrežica za ventilator: M45/9653 in M45/9653

Pakirano po 1 kos.

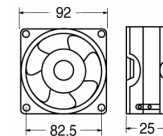

koda	napetost	moč	obrati/min
M45/9601	12V DC	3,1W	3200
M45/9602	24V DC	4,1W	3200
M45/9603	220V AC	13W	2800

VENTILATOR 60x60x12mm

Ventilator aksialni 120x120x25mm
z ležaji in senzorjem vrtenja

Loputa: poliester
Drсни kontakti: ležaji
Šum: 30dB
Delovna temperatura: -20°C +80°C
Priključek na kablju s 3 polnim konektorjem

Pakirano po 1 kos.

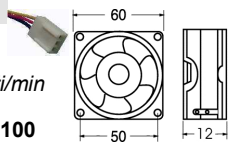

koda	napetost	moč	obrati/min
M45/9591B	12V DC	1,56W	2100

VENTILATOR 120x120x38mm

Ventilator aksialni 120x120x38mm

Loputa: poliester
Drсни kontakti: puša
Šum: 45dB
Delovna temperatura: -10°C +70°C
Mrežica za ventilator: M45/9655 in M45/9690.
Pakirano po 1 kos.

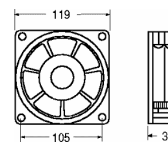

koda	napetost	moč	obrati/min
M45/9604	12V DC	7,0W	3000
M45/9606	24V DC	8,6W	3000
M45/9609	110V DC	18W	3000
M45/9610	220V AC	22W	3000

VENTILATOR 60x60x25mm

Ventilator aksialni 60x60x25mm
z ležaji

Loputa: poliester
Drсни kontakti: ležaji
Šum: 30dB
Delovna temperatura: -20°C +80°C

Pakirano po 1 kos.

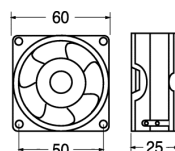

koda	napetost	moč	obrati/min
M45/9591C	12V DC	1,56W	4000
M45/9592	24V DC	2,88W	4000

VENTILATOR 120x120x25mm

Ventilator aksialni 120x120x25mm
z ležaji in senzorjem vrtenja

Loputa: poliester
Drсни kontakti: ležaji
Šum: 35dB
Delovna temperatura: -20°C +80°C
Priključek na kablju s 3 polnim konektorjem

Pakirano po 1 kos.

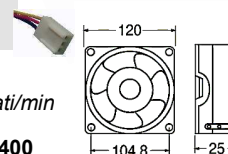

koda	napetost	moč	obrati/min
M45/9604B	12V DC	1,2W	1400

VENTILATOR 120x120x38mm

Ventilator aksialni 120x120x38mm z ležaji

Loputa: poliester
Drnsni kontakti: ležaji
Šum: 45dB
Delovna temperatura: -20°C +80°C
Mrežica za ventilator: M45/9655 in M45/9690.



Pakirano po 1 kos.

Koda	napetost	moč	obrati/min
M45/9642	24V DC	8,6W	3000
M45/9606B	48V DC	8,1W	2700
M45/9644	230V AC	18W	3000

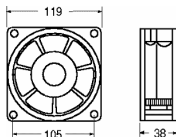

VENTILATOR 120x120x31mm

Ventilator aksialni v škatli 120x120x31mm z ležaji

Loputa: poliester
Drnsni kontakti: ležaji
Šum: 45dB
Delovna temperatura: -20°C +80°C



Pakirano po 1 kos.

koda	napetost	moč	obrati/min
M45/9635	12V CC	13,2W	2700
M45/9633	24V CC	12,2W	2700

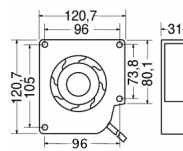

VENTILATOR 120x120x25mm

Ventilator aksialni 120x120x25mm z ležaji

Loputa: poliester
Drnsni kontakti: ležaji
Šum: 46dB
Delovna temperatura: -20°C +80°C
Mrežica za ventilator: M45/9653 in M45/9653



Pakirano po 1 kos.

koda	napetost	moč	obrati/min
M45/9640	230V AC	19W	2400

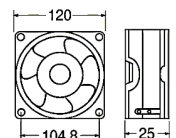

ZAŠČITNA MREŽICA ZA VENTILATOR

Zaščitna mrežica za ventilator.

Material: niklan aluminij
Pakirano po 1 kos.

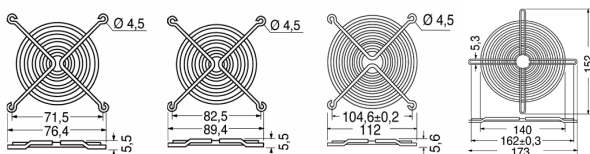

80x80mm 92x92mm 120x120mm 172x172mm

koda za ventilatorje

M45/9650	80x80mm
M45/9653	92x92mm
M45/9655	120x120mm
M45/9656	172x150mm

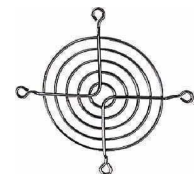

VENTILATOR 172x150x51mm

Ventilator aksialni 172x150x51mm z ležaji.

Loputa: poliester
Drnsni kontakti: ležaji
Šum: 45dB
Delovna temperatura: -20°C +80°C
Mrežica za ventilator: M45/9656
Pretok zraka: 360m³/h



Pakirano po 1 kos.

koda	napetost	moč	obrati/min
M45/9649	220V AC	32W	3100

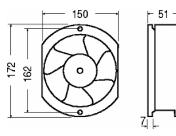

Zaščitna mrežica za ventilator s filtrom.

Material: PVC z microfiltrom iz acryl-a. Pakirano po 1 kos.

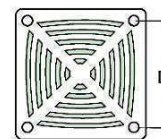

koda za ventilatorje D mm

M45/9670	80x80mm	72mm
M45/9680	92x92mm	82mm
M45/9690	120x120mm	104,5mm

VENTILATOR 172x51mm

Ventilator aksialni 172x51mm z ležaji, nizkošumni.

Loputa: poliester
Drnsni kontakti: ležaji
Šum: 35dB
Delovna temperatura: -20°C +80°C
Mrežica za ventilator: M45/9656
Pretok zraka: 280m³/h



Pakirano po 1 kos.

koda	napetost	moč	obrati/min
M45/9649C	220V AC	29W	2300

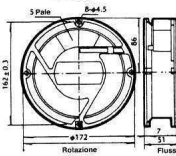

V IZDELAVI

POLNILNE BATERIJE ZA PRENOSNE TELEFONE



BN30/15202
PHILIPS
ALORIS



BN30/15213
PANASONIC
KX-A36A



BN30/15219
UNIVERZALNI KONEKTOR



BN30/15203
SAMSUNG



BH30/15267
PHILIPS



BH30/15165



BN30/130
PANASONIC KX-A43



BN30/125
PANASONIC KX-T9100



BN30/15156
PANASONIC KX-T4000

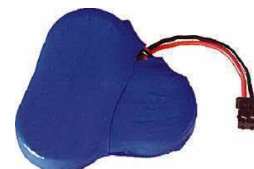

BN30/15101
PANASONIC

Koda	tip	napetost	kapaciteta	dimenzija	pak.
BN30/15202	Ni-Cd 3x2/3AA	3,6V	300mAh	44x31x14,5mm	1 kos
BN30/15213	Ni-Cd 3x2/3AA	3,6V	300mAh	44x31x14,5mm	1 kos
BN30/15219	Ni-Cd 3x2/3AA	3,6V	300mAh	44x31x14,5mm	1 kos
BN30/15203	Ni-Cd 2x2/3AA	2,4V	300mAh	29x31x14,5mm	1 kos
BH30/15267	Ni-Mh 2xAAA	2,4V	600mAh	45x21x10,5mm	1 kos
BH30/15165	Ni-Mh 3x2/3AAA	3,6V	280mAh	30x31x10mm	1 kos
BN30/130	Ni-Cd 3xAA	3,6V	600mAh	44x54x16mm	1 kos
BN30/125	Ni-Cd 4xAA	4,8V	600mAh	56x65x17mm	1 kos
BN30/15156	Ni-Cd	3,6V	130mAh	52,4x14mm	1 kos
BN30/15101	Ni-Cd DETELJICA	3,6V	280mAh	48x51x9mm	1 kos

POLNILNE BATERIJE



BH30/175B



BH30/190A

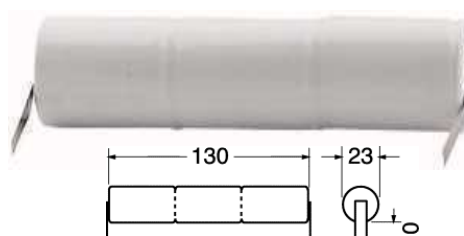

BN30/15644

Koda	tip	napetost	kapaciteta	dimenzija	pak.
BH30/175B	Ni-Mh 3xAA	3,6V	2200mAh	44x50x14,5mm	1 kos
BH30/190A	Ni-Mh 4xAA	4,8V	2200mAh	58x50x14,5mm	1 kos
BN30/15644	Ni-Cd 3xSC	3,6V	2000mAh	130x23mm	1 kos



Ni-Cd POLNILNE BATERIJE



Koda	tip	slika	napetost	kapaciteta	dimenzija b x a	pak.
BN30/267	Ni-Cd 2/3AF	B	1,2V	700mAh	17x29mm	1 kos
BN30/231	Ni-Cd 4/5A	B	1,2V	1.200mAh	17x43mm	1 kos
BN30/286	Ni-Cd 4/3A	A	1,2V	2.000mAh	17x67mm	1 kos
BN30/296	Ni-Cd 4/5SC	C	1,2V	1.200mAh	23x34mm	1 kos
BN30/307	Ni-Cd SC	C	1,2V	2.000mAh	23x43mm	1 kos
BN30/410	Ni-Cd D	C	1,2V	5.000mAh	33x61mm	1 kos
BN30/453	Ni-Cd RSH 7	F	1,2V	7.000mAh	33x91mm	1 kos

Ni-Mh POLNILNE BATERIJE

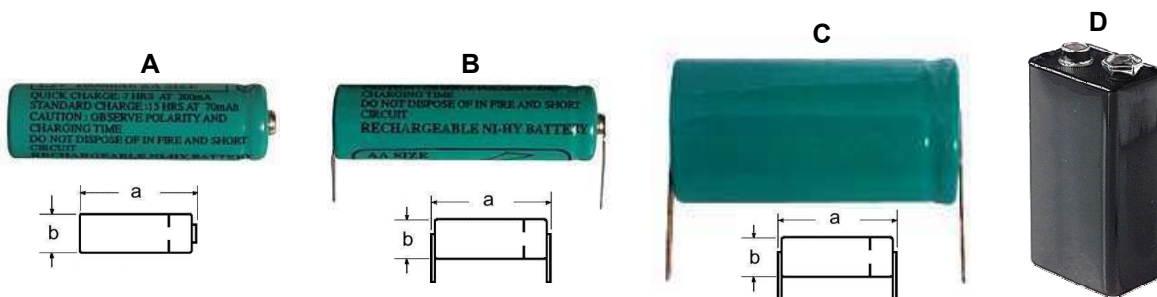

Koda	tip	slika	napetost	kapaciteta	dimenzija b x a	pak.
BH30/207H	Ni-Mh AA	A	1,2V	2.400mAh	14,5x50,5mm	1 kos
BH30/219	Ni-Mh AA	B	1,2V	2.400mAh	14,5x50,5mm	1 kos
BH30/253	Ni-Mh 1/3AA	B	1,2V	180mAh	14,5x17mm	1 kos
BH30/285	Ni-Mh AAA	B	1,2V	750mAh	11x45mm	1 kos
BH30/291	Ni-Mh 4/3A	B	1,2V	3.500mAh	17x66,5mm	1 kos
BH30/371	Ni-Mh C	C	1,2V	4.000mAh	26x50mm	1 kos
BH30/500	Ni-Mh 9V	D	9V	160mAh	26x48,5x17,5mm	1 kos

GUMB BATERIJE

koda	oznaka IEC	napetost	dimenzija	pakirano	zamenjava za modele
BS301	301	1,55V	4,2x11,6mm	10 kos	386, SR43, WS11, RW34,
BS357	357	1,55V	5,4x11,6mm	10 kos	303, SR44, RW42
BS362	362	1,55V	2,1x7,9mm	10 kos	361, SR58, SR721, RW310
BS377	377	1,55V	2,6x6,8mm	10 kos	SR626, 606, RW329, SR66
BS384	384	1,55V	3,6x7,9mm	10 kos	392, SR41, 247, RW37
BS389	389	1,55V	3,05x11,6mm	10 kos	390, SR1130, RW49, SR54
BS391	391	1,55V	2,1x11,6mm	10 kos	381, SR1120, RW40, SR55
BS397	397	1,55V	2,6x7,9mm	10 kos	396, SR726, RW311, SR59
BV675A	V675A	1,4V	5,4x11,6mm	6 kos	PRX675, DA675, PR44
BV12GA	LR43	1,5V	4,2x11,6mm	10 kos	RW84
BV13GA	LR44	1,5V	5,4x11,6mm	10 kos	RW82

Zn-C BATERIJA 6V S FEDERČKI

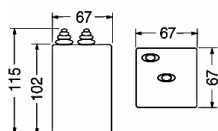

koda	oznaka	napetost	dimenzija	pak.
BZ4R25	4 R 25	6V	24,9x14,5mm	1 kos

LITIJEVE GUMB BATERIJE



CR 2016
CR 2025
CR 2032
CR 2450
CR2430
CR2477



CR2032TV

koda	oznaka IEC	napetost	dimenzija	pakirano
BCR2016	CR2016	3V	1,6x20mm	5 bat.
BCR2025	CR2025	3V	2,5x20mm	5 bat.
BCR2032	CR2032	3V	3,2x20mm	5 bat.
BCR2032TV	CR2032	3V	3,2x20mm	1 bat.
BCR2354	CR2354	3V	5,4x23mm	1 bat.
BCR2430	CR2430	3V	3x24,5mm	1 bat.
BCR2477N	CR2477N	3V	7,7x24,7mm	1 bat.



CR2354

LITIJEVE BATERIJE 3 in 3,6V

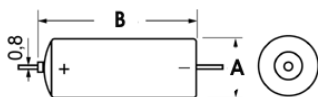

slika A

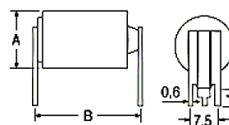

slika B



koda	oznaka IEC	napetost	dimenzija a x b	slika	pakirano
BL30/3140	1/2AA	3,6V	14,5x24,9mm	A	1 kos
BL30/3240	AA	3,6V	14,5x50,4mm	A	1 kos
BL30/3248B	2/3AA	3,6V	14,5x28mm	A	1 kos
BL30/3250	2/3A	3,7V	17x33mm	A	1 kos
BL30/3340	C	3,6V	26x49,8mm	A	1 kos
BL30/3360	D	3,6V	32x60mm	A	1 kos
BL30/3600	1/2AA	3V	14,5x24,9mm	B	1 kos
BL30/3660	2/3AF	3V	17x33mm	B	1 kos

LITIJEVE BATERIJE - FOTO



2 CR 5



CR 123 A



CR 2

koda	oznaka IEC	napetost	dimenzija	pakirano, minimalna količina
B2CR5	2 CR 5	6V	34x17x45mm	1 bat. v blistru, 10 bat. v škatli
BCR2	CR 2	5V	27x15mm	1 bat. v blistru, 10 bat. v škatli
BCR123A	CR 123A	3V	34x17mm	1 bat. v blistru, 10 bat. v škatli

ALKALNE BATERIJE ZA DALJINCE



10 A
11 A
23 A
25 A
27 A



LR1

koda	oznaka IEC	napetost	dimenzija	pakirano, minimalna količina
B30/2118	27A	12V	8x27mm	1 kos
B30/2120	11A	6V	10x16mm	1 kos
B30/2125	10A	9V	10x22mm	1 kos
B30/2125A	25A	9V	8x25mm	1 kos
B30/2130	23A	12V	10x29mm	1 kos
BA4001	LR 1	1,5V	12x30mm	1 bat. v blistru, 10 bat. v škatli

SUHO SVINČENE (Pb) POLNILNE BATERIJE

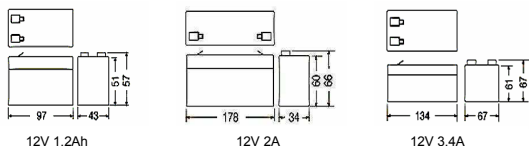

koda	napetost	kapaciteta	dimenzija	pak.
BPB12V1.2A	12V	1,2Ah	97x43x57mm	1 kos
BPB12V2A	12V	2Ah	178x35x68mm	1 kos
BPB12V3.4A	12V	3,4Ah	134x67x67mm	1 kos
BPB12V4.2A	12V	4,2Ah	90x70x108mm	1 kos

Svinčena 12V polnilna baterija.

Hermetično zaprta. Brez vzdrževanja.
Primerna za ciklično ali stand-by uporabo.
Polnilec: BN30/8711 ali W13/10100

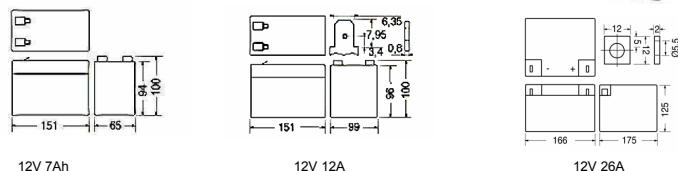

koda	napetost	kapaciteta	dimenzija	konektor	pak.	uporaba
BPB12V7A	12V	7Ah	151x65x101mm	faston 6,3mm	1 kos	stand-by
BPB12V7A-POWER	12V	7Ah	151x65x101mm	faston 6,3mm	1 kos	UPS
BPB12V8A	12V	8Ah	151x65x101mm	faston 4,8mm	1 kos	UPS
BPB12V12A	12V	12Ah	151x99x101mm	faston 6,3mm	1 kos	
BPB12V26A	12V	26Ah	166x175x125mm	vijak M5	1 kos	

Svinčena 12V polnilna baterija.

Hermetično zaprta.
Brez vzdrževanja.
Primerna za ciklično, hitro praznenje, ali stand-by uporabo.
Polnilec: BN30/8711 ali W13/10100

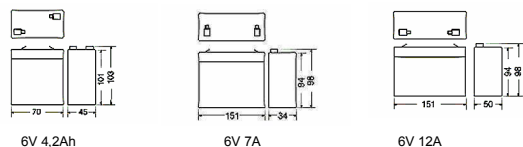

koda	napetost	kapaciteta	dimenzija	pak.
BPB6V4A	6V	4,2Ah	70x47x107mm	1 kos
BPB6V7A	6V	7Ah	151x34x100mm	1 kos
BPB6V12A	6V	12Ah	151x50x100mm	1 kos

Svinčena 6V polnilna baterija.

Hermetično zaprta. Brez vzdrževanja.
Primerna za ciklično ali stand-by uporabo.
Polnilec: BN30/8704

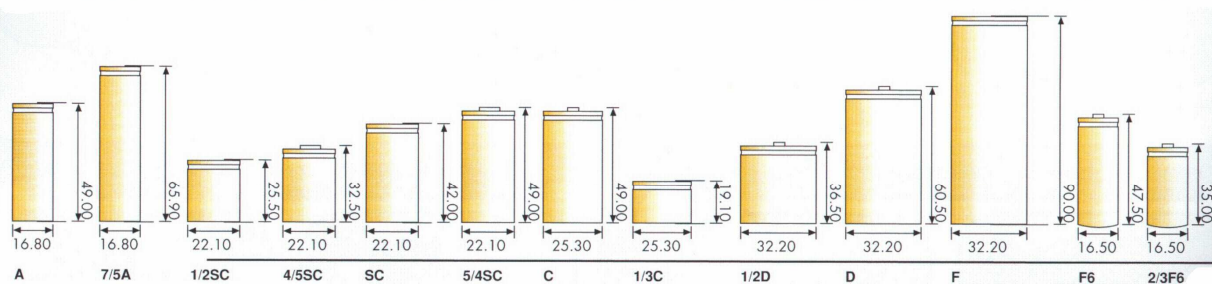
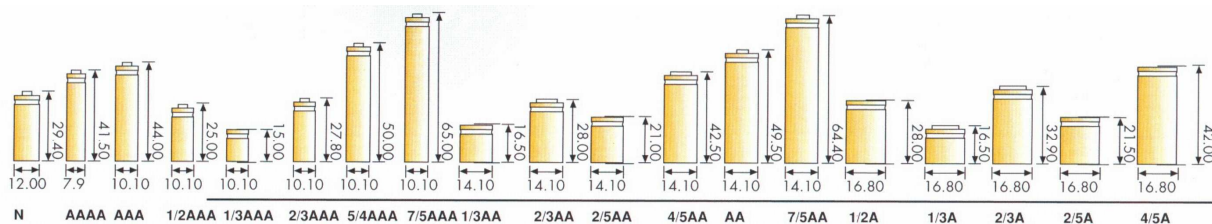

**BATERIJA ZA ROČNO ORODJE
BOSCH**

Baterija je kopija originala. Vsebuje kvalitetne celice japonskih proizvajalcev (Panasonic).



Koda	tip	napetost	kapaciteta	koda BOSCH
BO520	Ni-Cd	14,4V	2,5Ah	2607335431
BO540	Ni-Mh	14,4V	3,0Ah	2607335685
BO543	Ni-Cd	24,0V	2,0Ah	2607335268
BO545	Ni-Mh	24,0V	3,0Ah	2607335268



Koda	tip	napetost	kapaciteta	koda BOSCH
BO560	Ni-Mh	12V	2,7Ah	2607335151



**BATERIJA ZA ROČNO ORODJE
MAKITA**

Baterija je kopija originala. Vsebuje kvalitetne celice japonskih proizvajalcev (Panasonic).



Koda	tip	napetost	kapaciteta	koda MAKITA
BO630	Ni-Mh	14,4V	2,5Ah	1434

**BATERIJA ZA ROČNO ORODJE
DEWALT / BLACK & DECKER**

Baterija je originalna, proizvajalca DEWALT.



Koda	tip	napetost	kapaciteta	koda DEWALT
BO710	Ni-Mh	18V	2,5Ah	DW9095, PS145
BO712	Ni-Cd	14,4V	1,3Ah	DW9094

**POLNILEC BATERIJ
BOSCH**

Polnilec baterij BOSCH.
Primeren za baterije Ni-Cd in Ni-Mh.



Koda	napetost	tok polnenja	koda BOSCH
BO590	7,2 - 14,4V	5A	AL1450DV
BO592	7,2 - 24V	5A	AL2445/50DV

NAPREKINJENO NAPAJanJE DIGITUS UPS



Neprekinjeno napajanje 1000VA DIGITUS LINE INTERACTIVE

Napajanje: 230VAC 50Hz $\pm 23\%$
Razsmerjeni izhod: modificirani sinus 230VAC 50Hz
Izhodna moč: 1000VA (700W)
Notranji vir napajanja: 2 bateriji Pb 12V 7Ah
Svetleči indikator: omrežne napetosti, stanje baterije, izhoda
Priključki na izhodu: 2x vtičnici shuko, 1x RS232, 1x USB,
x telefonski vtikač 6/4 (s prenapetostno zaščito)
Dimenzije: 350x120x195mm
Teža: 10Kg

koda	artikel DIGITUS	izhodna moč	pakiranje
W13/17000	DN-170014	1000VA (700W)	1 kos



Neprekinjeno napajanje 1000VA s klemami DIGITUS LINE INTERACTIVE

Predelan UPS z dodanimi klemami, namenjen za napajanje pumpe centralnega ogrevanja. Ob ispadu omrežne napetosti UPS preklopi na zunanji vir napajanja (bateriji). Ob vrnitvi omrežne napetosti se prične avtomatsko polnjenje akumulatorja. Z dvema zunanjima štartnima akumulatorjema 12V 55Ah, pumpa moči 80W lahko obratuje do 7h, kar zadostuje da se peč na trda goriva ohladi.

Napajanje: 230VAC 50Hz $\pm 23\%$
Razsmerjeni izhod: modificirani sinus 230VAC 50Hz
Izhodna moč: 1000VA (700W)
Zunanji vir napajanja: 2 bateriji 12V (niso priložene)
Svetleči indikator: omrežne napetosti, stanje baterije, izhoda
Priključki na izhodu: 2x vtičnici shuko, 1x RS232, 1x USB,
x telefonski vtikač 6/4 (s prenapetostno zaščito)
Dimenzije: 350x120x195mm

koda	artikel DIGITUS	izhodna moč	pakiranje
W13/17000K	DN-170014	1000VA (700W)	1 kos



Neprekinjeno napajanje 1500VA z LCD prikazovalnikom DIGITUS LINE INTERACTIVE

Na LCD prikazovalniku so istočasno prikazani vhodna in izhodna napetost in trenutno stanje baterije v %.

Napajanje: 230VAC 50Hz $\pm 23\%$
Razsmerjeni izhod: modificirani sinus 230VAC 50Hz
Izhodna moč: 1500VA (1100W)
Notranji vir napajanja: 2 bateriji 12V 9Ah
LCD prikazovalnik stanja
Priključki na izhodu: 2x vtičnici shuko, 1x RS232, 1x USB,
x telefonski vtikač 6/4 (s prenapetostno zaščito)
Dimenzije: 350x120x195mm
Teža: 11,5Kg

koda	artikel DIGITUS	izhodna moč	pakiranje
W13/17500K	DN-170015	1500VA (1100W)	1 kos

V IZDELAVI

**VIDEO KABEL VR-23
2 VTIKAČA TV 9,5mm**

Za povezavo med VCR, SAT, ali antene z TV.
Za RF signal.



koda	dolžina	barva kabla	tip kabla
KVR23	2m	črna	RG59

**VIDEO KABEL VR-25
VTIKAČ - VTIČNICA TV 9,5mm**

Za povezavo med VCR, SAT, ali antene z TV.
Za RF signal.



koda	dolžina	barva kabla	tip kabla
KVR25	2m	črna	RG59
KVR25/3	3m	bela	sat kabel
KVR25/4	4m	bela	sat kabel
KVR25/5	5m	bela	sat kabel
KVR25/10	10m	bela	sat kabel

**VIDEO KABEL VR-35
2 VTIKAČA SCART, 9 POLNA VEZAVA**

Dvosmerni video kabel za povezavo med VCR (VHS ali S-VHS), SAT, DVD, z TV,... 9 polna vezava.



koda	dolžina	opomba
KVR35	1,5m	/
KVR35/2	2m	/
KVR35/3	3m	/
KVR35/4	4m	/
KVR35/5	5m	/
KVR35/5KOAKS	5m	koaksialni kabel brez izgub
KVR35/10KOAKS	10m	koaksialni kabel brez izgub
KVR35/15KOAKS	15m	koaksialni kabel brez izgub

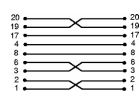

**VIDEO KABEL VR-99
2 VTIKAČA SCART, 21 POLNA VEZAVA**

Dvosmerni video kabel za povezavo med VCR (VHS ali S-VHS), SAT, DVD, z TV,...
21 polna vezava.



koda	dolžina
KVR99	1,5m

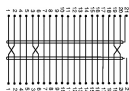

**VIDEO KABEL VR-99 GOLD
2 VTIKAČA SCART POZLAČENA**

Profesionalno izdelan video kabel z namenom čim **boljšega prenosa video in avdio signala.**
Narejen je iz posebnega 75 Ohm koaksialnega kabla, ki omogoča prenos avdio in video signala praktično brez izgub!
Za perfektni stik skrbita še pozlačena vtičača scart.
21 polna vezava.
Za povezavo med DVD, VCR (VHS ali S-VHS), SAT, z TV,...

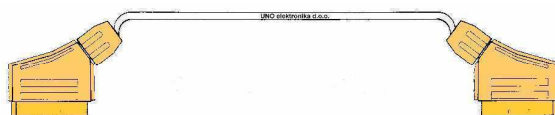

koda	dolžina
KVR99/2GOLD	2m

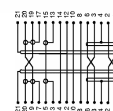

**VIDEO KABEL VR-38
VTIKAČ SCART - 4 VTIKAČI RCA**

Za povezavo med VCR, SAT, PC, VIDEO KAMERO z TV,...

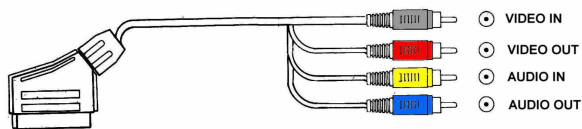

koda	dolžina	opomba
KVR38	1,2m	/
KVR38/2	2m	/
KVR38/3	3m	/

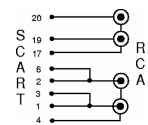

**VIDEO KABEL VR-41
VTIKAČ SCART - 6 VTIKAČEV RCA**

Za povezavo med VCR, SAT, PC z TV,...

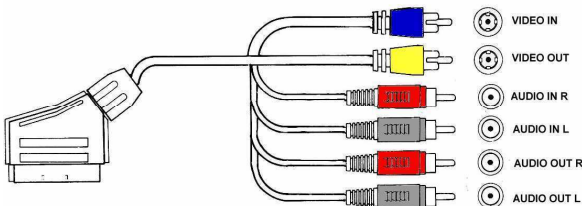

koda	dolžina	opomba
KVR41	1,2m	/
KVR41/2	2m	/

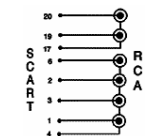

**VIDEO KABEL VR-70
PODALJŠEK: VTIKAČ-VTIČNICA SCART**

Podaljšek za scart/scart kabel. 9 polna vezava.



koda	dolžina	opomba
KVR70	1,2m	/
KVR70/2	2m	/

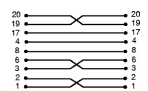

**KABEL HDMI
2 VTIKAČA HDMI 9p. TIPA A**

Kabel je namenjen prenosu (digitalnega) zvoka in slike v visoki resoluciji full HD 1080p , pri hitrosti 4,5gbit/s. Primeren za medsebojno povezavo naprav: TV, hišnega kina, set top box, DVBT (digitalna zemeljska TV), SAT, camcorderje,....



koda	dolžina	barva kabla
THDMI	2m	črna
THDMI/3	3m	črna
THDMI/5	5m	črna
THDMI/10	10m	črna

**VIDEO KABEL VR-26
VTIKAČ - VTIKAČ RCA**

Za povezavo med PC, VCR, ali ISAT z TV.
Za VIDEO in AUDIO signal. 75 Ohmski kabel RG175



koda	dolžina	barva kabla	tip kabla
KVR26/2	2m	črna	RG175
KVR26/3	3m	črna	RG175
KVR26/5	5m	črna	RG175
KVR26/10	10m	črna	RG175

**VIDEO KABEL VR-63
2 + 2 VTIKAČA RCA POZLAČENA**

Za medsebojno povezavo komponent HI-FI stolpa, med avtokasetofonom - CD izmenjevalcem in avtoojačevalcem, za prenos video signala,....
Vtikači RCA so pozlačeni, kovinske izvedbe z uvodnico.
Kabel je OFC, debelejši, dimenzije 4x8mm.

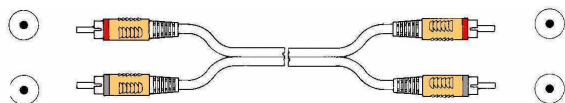

koda	dolžina	tip kabla	barva kabla
KVR63/0.7	0,7m	OFC kabel	črna
KVR63	1,2m	OFC kabel	črna
KVR63/4	4m	OFC kabel	črna
KVR63/5	5m	OFC kabel	črna
KVR63/5E	5m	tanek 2x0,14	črna
KVR63/10	10m	OFC kabel	črna

**VIDEO KABEL VR-66 S-VHS
2 VTIKAČA MINI DIN 4 p.**

Za medsebojno povezavo S-VHS komponent kot so DVD, VIDEO KAMERE , PC z TV ali monitorjem.
Med vtikača mini din potuje S-VHS signal (slika).



koda	dolžina	opomba
KVR66	1,2m	/
KVR66/2	2m	/
KVR66/3	3m	/
KVR66/5	5m	koaksialni S-VHS kabel
KVR66/6	6m	koaksialni S-VHS kabel
KVR66/10	10m	koaksialni S-VHS kabel

**AVDIO KABEL M-124
2 VTIKAČA RCA - 2 VTIKAČA RCA**

Za medsebojno vezavo komponent HI-FI stolpa, PCja in ojačevalca, za prenos video in avdio signala,....

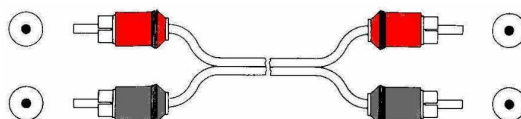

koda	dolžina	opomba
KM124	1,2m	/
KM124/2	2m	/
KM124/3	3m	/
KM124/4	4m	/
KM124/5	5m	/
KM124/6	6m	/

**AVDIO KABEL M-200
VTIKAČ JACK 3,5mm - 2 VTIKAČA RCA**

Za vezavo PCja, WALKMENA, MINI DISKa, CD PLAYERja,.... z HI-FI ojačevalcem,.....

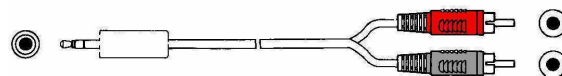

koda	dolžina	opomba
KM200	1,2m	/
KM200/2	2m	/
KM200/3	3m	/
KM200/4	4m	/
KM200/5	5m	/
KM200/6	6m	/
KM200/7	7m	/
KM200/10	10m	/

UNO elektronika d.o.o.
Dolenja vas 1b, 6224 Senožeče
tel. 05 76-56-140 fax. 05 76-56-141
www.unoelektronika.si

sestavljanje AVDIO-VIDEO kablov po naročilu

**AVDIO KABEL M-196
2 VTIKAČA JACK 3,5mm STEREO**

Za medsebojno vezavo PCjev, med prenosnim CD PLAYERjem in PCjem, WALKMENom in PCjem,.....

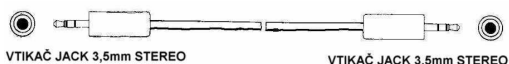

koda dolžina opomba

KM196	1,2m	/	
KM196/2	2m	/	
KM196/4	4m	/	

**AVDIO KABEL M-197
VTIKAČ - VTIČNICA JACK 3,5mm STEREO**

Uporablja se kot podaljšek.



koda dolžina opomba

KM197	1,2m	/	
KM197/2	2m	/	
KM197/3	3m	/	
KM197/4	4m	/	
KM197/5	5m	/	
KM197/8	8m	/	

V IZDELAVI

V IZDELAVI

**KONEKTOR ADAPTER
VTIKAČ SCART - 3 VTIČNICE RCA
+ VTIČNICA MINI DIN 4 POLNA S-VHS**

Dvosmerni adapter za avdio - video signal.
Preko vtičnic RCA potuje video signal, preko vtičnico mini din 4 polno pa S-VHS signal.
Uporabljamo ga za povezavo VIDEO KAMERE ali VCR na TV.



koda pakirano kos

KVR45/7342	1
------------	---

**PREKLOPNIK
ZA 4 VIDEO APARATE**

Video preklopnik za 4 video aparate(VCR, SAT, DVD, video kamera,...)
Ima 3 vhode s tremi RCA vtičnicami (stereo), 1 vhod s tremi RCA vtičnicami (stereo) in S-VHS vhodom.
Izhod ima tri RCA vtičnice (stereo) in en S-VHS izhod.
Preklop med aparati je s pomočjo drsnega stikala.
Ne potrebuje napajanja.



koda pakirano kos

KVR45/7412	1
------------	---

**RAZDELILNIK SCART 3 MESTNI
VTIKAČ SCART - 3 VTIČNICE SCART**

Za povezovanje 3 aparatov z TV.
Preko vtičnici scart povezujemo lahko VCR, SAT, VIDEO KAMERO,.....
Vtičnice SCART so vezane med sabo vzporedno.
Dolžina kabla: 0,5m
Vezava: 21 polna



koda pakirano kos

KVR45/7339	1
------------	---

PATCH KABEL UTP CAT5e

Patch kabel UTP CAT5e.

Za povezovanje računalniške opreme.

Konektorja 2x RJ45. Vezava 1:1 po standardu 568. Preizkušeni 100%!

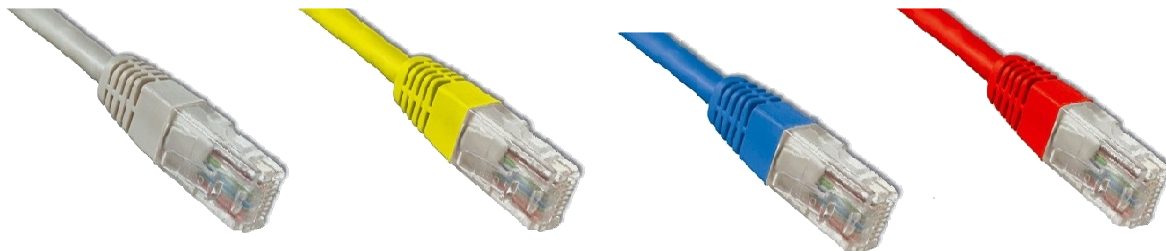

koda	dolžina	barva kabla	pakiranje
TPU0.5SI	0,5m	siva	1 kos
TPU0.5RD	0,5m	rdeča	1 kos
TPU0.5PL	0,5m	modra	1 kos
TPU01SI	1m	siva	1 kos
TPU01RD	1m	rdeča	1 kos
TPU01PL	1m	modra	1 kos
TPU02SI	2m	siva	1 kos
TPU02PL	2m	modra	1 kos
TPU02RU	2m	rumena	1 kos
TPU02ZE	2m	zelena	1 kos

koda	dolžina	barva kabla	pakiranje
TPU03SI	3m	siva	1 kos
TPU03RD	3m	rdeča	1 kos
TPU03PL	3m	modra	1 kos
TPU03ZE	3m	zelena	1 kos
TPU05SI	5m	siva	1 kos
TPU10SI	10m	siva	1 kos
TPU15SI	15m	siva	1 kos
TPU20SI	20m	siva	1 kos
TPU30SI	30m	siva	1 kos

Po naročilu dobavljive tudi druge barve in dolžine!

KABEL ZA MONITOR IN PROJEKTOR

Kabel za vezavo PC monitorjev in projektorjev

Visoko kvalitetni kabel z vgrajenim feritom (3x coax kabel za RGB signal, + 7x AWG28 signalni kabel, dvojni oklop).
Za prenos VGA (640x480 pik) do 30m in SXGA signala (1280x1024 pik) do 20m . Konektor SUB HD15 polni.



koda	dolžina	konektorja	pakiranje
TVGA10	1,8m	vtikač/vtikač	1 kos
TVGA10/03	3m	vtikač/vtikač	1 kos
TVGA10/05	5m	vtikač/vtikač	1 kos
TVGA10/10	10m	vtikač/vtikač	1 kos
TVGA10/15	15m	vtikač/vtikač	1 kos
TVGA10/20	20m	vtikač/vtikač	1 kos
TVGA10/30	30m	vtikač/vtikač	1 kos



koda	dolžina	konektorja	pakiranje
TVGA09	1,8m	vtikač/vtičnica	1 kos

**KONEKTOR ADAPTER
SUB HD15p. VTIČNICA / VTIČNICA**



Konektor adapter SUB HD15p. vtičnica / vtičnica

Kovinska izvedba
Vezava 1:1

koda	konektor	pakiranje
TVGA20	2x vtičnica SUB HD15p.	1

**KONEKTOR ADAPTER
SUB HD15p. VTIKAČ / VTIKAČ**



Konektor adapter SUB HD15p. vtikač / vtikač

Kovinska izvedba
Vezava 1:1

koda	konektor	pakiranje
TVGA21	2x vtikač SUB HD15p.	1

NAPAJALNI KABEL EURO/EURO

Kabel vtikač - vtičnica euro 3 polna.

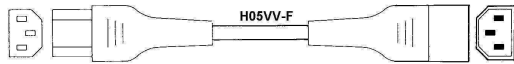

koda	dolžina	tok	kabel mmq	barva
M009	2m	10A 230V	3x0,75	črna
M009/3	3m	10A 230V	3x0,75	črna
M009/5	5m	10A 230V	3x0,75	črna

NAPAJALNI KABEL SHUKO/EURO

Kabel vtikač shuko pod kotom- vtičnica euro 3 polna ravna.

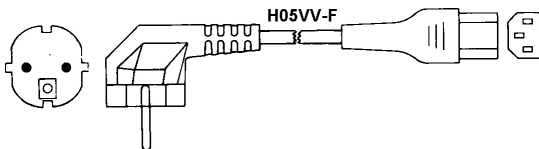

koda	dolžina	tok	kabel mmq	barva
M010	2m	10A 230V	3x0,75	črna
M010/3	3m	10A 230V	3x0,75	črna
M010/5	5m	10A 230V	3x0,75	črna

NAPAJALNI KABEL SHUKO/EURO

Kabel vtikač shuko pod kotom- vtičnica euro 3 polna pod kotom.

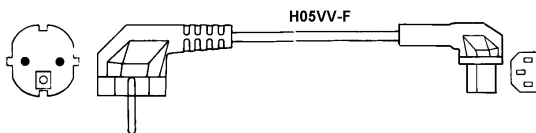

koda	dolžina	tok	kabel mmq	barva
M0105	1,8m	10A 230V	3x0,75	črna

KABEL ZA RADIOAPARATE

Kabel vtikač 2 polni - vtičnica 2 polna za napajanje radioaparatorov.

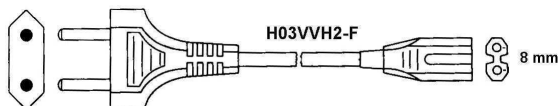

koda	dolžina	tok	kabel mmq	barva
M012	2m	2,5A 230V	2x0,75	črna

KABEL ZA BRIVNIKE

Kabel špiralni, vtikač 2 polni - vtičnica 2 polna za električne brivske aparate.

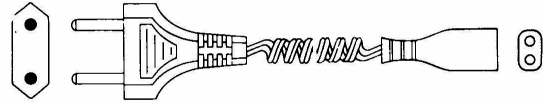

koda	dolžina	tok	kabel mmq	barva
M013	1,5m	2,5A 230V	2x0,25	črna

KABEL Z VMESNIM STIKALOM

Kabel vtikač 2 polni - prosti konec z vmesnim stikalom.

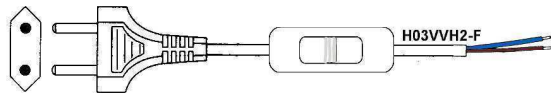

koda	dolžina	tok	kabel mmq	barva
M008B	2,2m	2,5A 230V	2x0,75	bela
M008Č	2,2m	2,5A 230V	2x0,75	črna

KABEL S PROSTIM KONCEM

Kabel vtikač 2 polni - prosti konec.

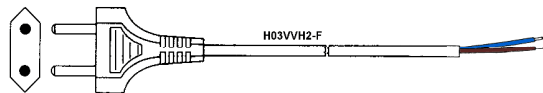

koda	dolžina	tok	kabel mmq	barva
M0138B	2m	2,5A 230V	2x0,75	bela
M0138Č	2m	2,5A 230V	2x0,75	črna

KABEL S PROSTIM KONCEM

Kabel vtikač shuko - prosti konec.

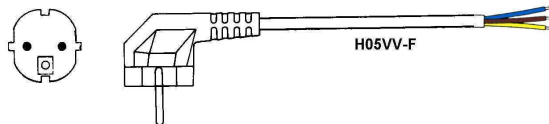

koda	dolžina	tok	kabel mmq	barva
M0139B	2m	10A 230V	3x0,75	bela
M0139/3B	3m	10A 230V	3x0,75	bela
M0139Č	2m	10A 230V	3x0,75	črna
M014B	2m	16A 230V	3x1,5	bela
M014/3B	3m	16A 230V	3x1,5	bela
M014/3Č	3m	16A 230V	3x1,5	črna
M014Č	2m	16A 230V	3x1,5	črna
M015B	2m	20A 230V	3x2,5	bela
M015Č	2m	20A 230V	3x2,5	črna
M016/3B	3m	20A 230V	3x2,5	bela

ANTENSKI KABEL SAT50306

Namenjen za povezovanje SAT in klasičnih TV anten.

Predlagane aplikacije: zemeljska TV, analogni in digitalni SAT signali, srednje-veliko razvejani kabelski sistemi. Na zunanjem plašču ima označeno metražo in kodo kabla. Koluti po 100m v kartonski embalaži.



koda	pak.	impedanca	zunanj plašč	notranji vodnik	oklop	slabljenje dB /100m
ASAT50306	100m	75 Ohm	fi 6,8mm PVC	fi 1,13mm Cu	100% Al folija + 30% Cu+Sn/St	860MHz= 18,3dB 1750MHz= 27,3dB

ANTENSKI KABEL SAT50306 V KOLUTIH PO 250m

Namenjen za povezovanje SAT in klasičnih TV anten.

Predlagane aplikacije: zemeljska TV, analogni in digitalni SAT signali, srednje-veliko razvejani kabelski sistemi.

Na zunanjem plašču ima označeno metražo in kodo kabla.

Koluti po 250m v kartonski embalaži.

Pri prvem nakupu podarimo kovinski nosilec koluta.

- Prednosti:
- pri odvijanju kabla ne prihaja do motanja kabla ("osmic")
 - ga lažje nosimo
 - ni potreben merilec kabla.

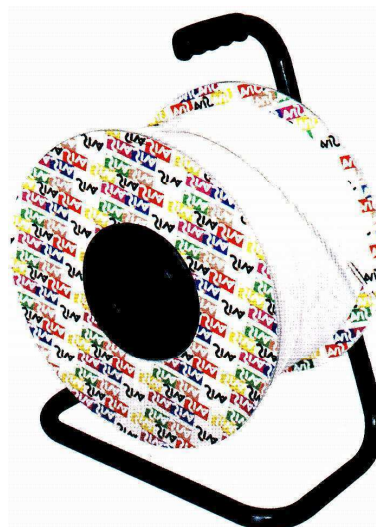

koda	kolut	karakteristike
ASAT50306-250	250m	enake kot pri kablu ASAT50306

ANTENSKI KABEL SAT37500 TANEK

Namenjen za povezovanje SAT in klasičnih TV anten, za kratke dolžine.

Predlagane aplikacije: zemeljska TV, analogni SAT signali, podaljški, ko v ceveh zmanjka prostora za debelejšje kable. Na zunanjem plašču ima označeno metražo in kodo kabla.



koda	pak.	impedanca	zunanj plašč	notranji vodnik	oklop	slabljenje dB /100m
ASAT37500	150m	75 Ohm	fi 5,3mm PVC	fi 0,8mm Cu	100% Al folija + 50% Cu+Sn/St	860MHz= 24,2dB 1750MHz= 35,7dB

ANTENSKI KABEL

Namenjen za povezovanje SAT in klasičnih TV anten.

Predlagane aplikacije: zemeljska TV, analogni SAT signali.

Na zunanjem plašču ima označeno metražo in kodo kabla. Koluti po 100m v kartonski embalaži.



koda	pak.	impedanca	zunanj plašč	notranji vodnik	oklop	slabljenje dB /100m
ASC80	100m	75 Ohm	fi 6,7mm PVC	fi 1,15mm Cu	78% Cu	860MHz= 19dB
ASC86	100m	75 Ohm	fi 6,7mm PVC	fi 1,15mm Cu	87% Cu+Ag	860MHz= 19dB

RG KOAKSIALNI KABLI 75 Ohm

Namenjeni za povezovanje TV kamer, monitorje, CATV sisteme, računalniške mreže, video domofone, za prenos podatkov,... Na zunanjem plašču imajo označeno kodo kabla. Koluti po 100m. Daljši koluti po naročilu.



koda	tip kabla	pak.	impedanca	zunanj plašč	notranji vodnik	oklop	slabljenje dB /100m
KKRG175	RG175AF	100m	75 Ohm	fi 2,8mm PLSF	fi 9x0,10mm	88% Cu+Sn/Pb	50MHz= 19,5dB
KKRG59U	RG59U	100m	75 Ohm	fi 6,2mm PVC	fi 0,64mm	95% Cu	50MHz= 7,4dB



koda	tip kabla	pak.	impedanca	zunanj plašč	notranji vodnik	oklop	slabljenje dB /100m
KKRG11AX	RG11AX	100m	75 Ohm	fi 10,3mm PVC	fi 7x0,40mm	97% Cu	50MHz= 4,1dB

RG KOAKSIALNI KABLI 50 Ohm

Namenjeni za povezovanje elektronskih instrumentov, oddajnike, sprejemnike, telekomunikacijskih naprav, računalniške mreže,... Na zunanjem plašču imajo označeno kodo kabla. Koluti po 100m. Daljši koluti po naročilu.



koda	tip kabla	pak.	impedanca	zunanj plašč	notranji vodnik	oklop	slabljenje dB /100m
KKRG174U	RG174U	100m	50 Ohm	fi 2,8mm PVC	fi 8x0,15mm	88% Cu	50MHz= 18,3dB
KKRG58AL	RG58AL	100m	50 Ohm	fi 5mm PVC	fi 19x0,18mm	86% Cu+Sn/Pb	50MHz= 9,7dB



koda	tip kabla	pak.	impedanca	zunanj plašč	notranji vodnik	oklop	slabljenje dB /100m
KKRG213U	RG213U	100m	50 Ohm	fi 10,3mm PVC	fi 7x0,75mm	97% Cu	50MHz= 4,3dB
KKRG214U	RG214U	100m	50 Ohm	fi 10,8mm PVC	fi 7x0,75mm	2x98% Cu+Ag	50MHz= 5,2dB

RG KOAKSIALNI KABEL 62 Ohm

Namenjen za povezovanje računalniških mrež. Na zunanjem plašču imajo označeno kodo kabla. Koluti po 100m. Daljši koluti po naročilu.



koda	tip kabla	pak.	impedanca	zunanj plašč	notranji vodnik	oklop	slabljenje dB /100m
KKRG62	RG62AU	100m	62 Ohm	fi 6,2mm PVC	fi 0,64mm	95% Cu	50MHz= 5,8dB

KABEL ČRNO / RDEČ

Kabel črno / rdeč za povezavo zvočnikov.

koda	dimenzija mmq
KA2X0.35	2 x 0,35
KA2X0.50	2 x 0,50
KA2X0.75	2 x 0,75
KA2X1	2 x 1
KA2X1.5	2 x 1,5
KA2X2	2 x 2
KA2X2.5	2 x 2,5



KABEL POLARIZIRAN

Kabel prozorni polariziran za povezavo zvočnikov.

koda	dimenzija mmq
KA2X1P	2 x 1
KA2X2P	2 x 2

po naročilu:
KA2X3P 2 x 3 FLEXI



KABEL Z OKLOPOM OZEK

Kabel z oklopom 2x0,08mmq ozek.
Namenjen za mini slušalke, mini konektorje,....
Za prenos avdio signala.



kolut

koda	kabel mmq	dimenzije	barva
KK2X0.08	2x0,08	2x3,5mm	črna

KABEL Z OKLOPOM STANDARD

Kabel z oklopom 2x0,14mmq standard.
Namenjen za slušalke, povezovanje avdio konektorjev,....
Za prenos avdio signala. Prenša tudi video signal do 10m.

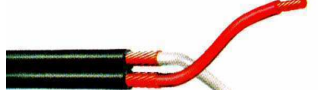

kolut

koda	kabel mmq	dimenzije	barva
KK2X0.14	2x0,14	2,8x5,5mm	črna

KABEL Z OKLOPOM ŠIROKI

Kabel z oklopom 2x0,25mmq široki ploščati.
Zelo trpežen. Majhna upornost in kapacitivnost.
Namenjen za povezovanje boljših avdio komponent.
Za prenos avdio signala (tudi na daljše razdalje do 200m).
Prenša tudi video signal do 20m.



kolut

koda	kabel mmq	dimenzije	barva
KK2X0.25	2x0,25	4x8mm	črna

KABLI MIKROFONSKI

Kabel mikrofonski 2x0,25mmq.
Namenjen za prenos avdio signala: za mikrofone, kitare,
ozvočenja,... Zelo gibljiv. Zunanji plašč iz gume.

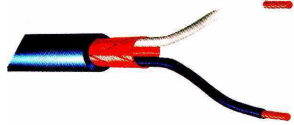

kolut

koda	kabel mmq	dimenzije	barva
KK2X0.25Č	2x0,25	fi 6mm	črna

KABEL MIKROFONSKI

Kabel mikrofonski 2x0,35mmq.
Namenjen za prenos avdio signala: za mikrofone, kitare,
ozvočenja,..... Fleksibilen.

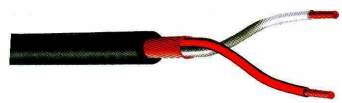

kolut

koda	kabel mmq	dimenzije	barva
KK2X0.35	2x0,35	fi 4,7mm	črna
KK2X0.35Č	2x0,35	fi 6,2mm	črna

KABLI Z OKLOPOM VEČŽILNI

Kabel z oklopom večžilni.
Namenjen za prenos avdio signala, podatkov,....
Prenša tudi video signal na kratke razdalje (5 do 8 m).

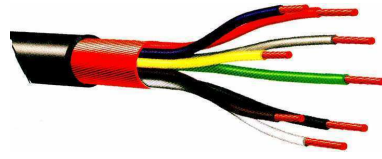

kolut

koda	kabel mmq	dimenzije	barva
KK2X0.50	2x0,50	fi 5,2mm	siva
KK4X0.22	4x0,22	fi 5,2mm	črna
KK4X0.5	4x0,5	fi 6mm	črna
KK7X0.14	7x0,14	fi 6mm	črna
KK7X0.5	7x0,5	fi 6,7mm	črna
KK8X0.22	8x0,22	fi 7,7mm	črna

KABEL Z OKLOPOM KOAKSIALNI

Kabel z oklopom 7 žilni:
4x0,14 + 1x0,25 + 2x0,14 oklopljen (75 Ohm).
Namenjen za prenos avdio in video signala.
Za video povezave domofonov, video nadzorov,....
Fleksibilen.



kolut

koda	kabel mmq	dimenzije	barva
KK7X0.14K	4x0,14+1x0,22+2x0,14	fi 9mm	črna

TELEFONSKI KABEL PLOŠČATI

Telefonski kabel 4 in 8 žilni ploščati AWG28.
Za mikro vtikače 4/4, 6/4, 6/6 in 8/8 serije T40/20100.
Klešča za krimpnanje mikrovitikačev tip T40/6035 in T40/6040.



koda	št. žil	barva kabla	pakiranje
KTEL/B	4	bela	kolut 100m
KTEL/Č	4	črna	kolut 100m
KTEL/S	4	siva	kolut 100m
KTEL8/B	8	beli	kolut 100m
KTEL8/Č	8	črni	kolut 100m

KABEL UTP CAT 5 E TRDE ŽILE

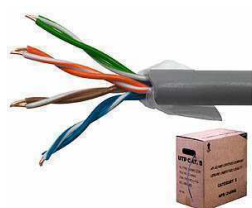

Kabel UTP CAT 5E 100Mhz trde žile (klasični).

4 parice AWG24.

Za mikrovitikače T40/21610.
Klešča za krimpnanje T40/6035 in T40/6040.

koda	št. žil	barva oklopa	pakiranje
T40/38010	4 parice	siva	škafka 305m

KABEL FTP CAT 5 E TRDE ŽILE



Kabel FTP CAT 5E 100Mhz trde žile (oklop iz alu folije + ena žička).

4 parice AWG24.

Za mikrovitikače T40/21110.
Klešča za krimpnanje T40/6035 in T40/6040.

koda	št. žil	barva oklopa	pakiranje
T40/38200	4 parice	siva	škafka 305m

KABEL FTP CAT 5 E FINOŽIČNI

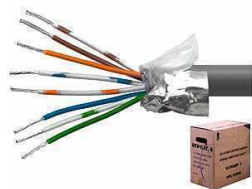

Kabel FTP CAT 5 E 100Mhz finožični (oklop iz alu folije + ena žička).

4 parice AWG24.

Namenjen za povezave na kratke razdalje, podaljške,....
Za mikrovitikače T40/21600.
Klešča za krimpnanje T40/6040.

koda	št. žil	barva oklopa	pakiranje
T40/40010	4 parice	siva	kolut 100m

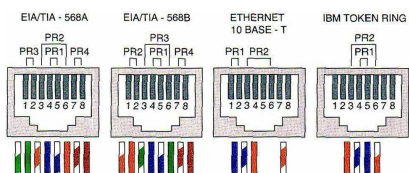

KLEŠČA ZA MIKROVITIKAČE

Klešča za krimpnanje mikrovitikačev.

Primerna za stiskanje mikrovitikačev:
4/4, 6/4, 8/8, 8/8 CAT 5.
Reže in blankira.
Material: PVC



koda	pakiranje
T40/6035	1 kos

KLEŠČA ZA MIKROVITIKAČE

Klešča za krimpnanje mikrovitikačev, profesionalna, kovinska izvedba.

Primerna za stiskanje mikrovitikačev:
4/4, 6/4, 8/8, 8/8 CAT 5.
Reže in blankira.



koda	pakiranje
T40/6040	1 kos

KABEL ZA TELEFONSKO SLUŠALKO

Kabel za telefonsko slušalko z mikrovitikači 4/4.
4 žilni kabel v spirali.



koda	dolžina maks.	barva
TSL4.5	4,5 m	siva

UNO elektronika d.o.o.
Dolenja vas 1b, 6224 Senožeče

tel. 05 76-56-140 fax. 05 76-56-141

TELEFONSKI MIKROVTIKAČI

Telefonski mikrovrtikači za ploščate kable.
Za 4 žilne telefonske kable tipa KTEL.
Klešča za krimpnanje mikrovrtikačev tip T40/6035 in T40/6040.

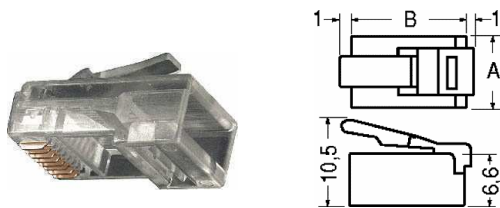

koda	tip	ohišje	kontakti	pakiranje	namen
T40/20100	4/4	4	4	20	tel. slušalka
T40/20110	6/4	6	4	20	tel. linija
T40/20120	6/6	6	6	20	ISDN
T40/20150	8/8	8	8	10	ISDN

MIKROVTIKAČI 8/8 CAT 5

Mikrovrtikači 8/8 CAT 5.
Za okrogle kable UTP, FTP, STP. (Za računalniške mreže).
Klešča za krimpnanje mikrovrtikačev tip T40/6035 in T40/6040.



koda	tip	oklop	pakiranje	za kable
T40/21610	CAT 5E	neoklopljen	10	UTP
T40/21600	CAT 5	neoklopljen	10	finožični UTP
T40/21110	CAT 5	oklopljen	10	FTP, STP

ZAŠČITA ZA MIKROVTIKAČE CAT 5

Zaščita za mikrovrtikače 8/8 CAT 5.
Za kable do premera 5,5mm.
V treh barvah. Za mikrovrtikače T40/21__ in T40/20150.

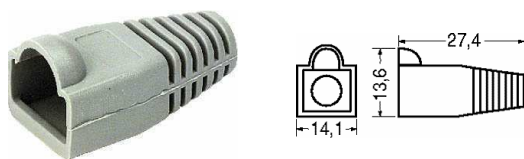

koda	barva	pakiranje
T40/23000	siva	10
T40/23010	črna	10
T40/23020	rdeča	10

MIKROVTIČNICA RJ45 ZA T.V.

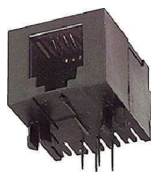

Mikrovrtičnica RJ45 8/8 za na tiskano vezje.

Za mikrovrtikače 8/8.

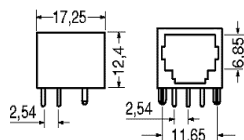

koda	pakiranje
T40/10130	1 kos

TELEFONSKI, ISDN, CAT5 ADAPTERJI

Telefonski adapter z dvema mikrovrtičnicama.

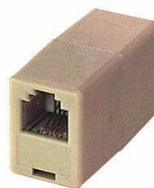

Primeren za podaljševanje linij telefonov, faxov, ISDN telefonov, brezžičnih telefonov, modemov, računalniških mrež CAT5,....

Za mikrovrtikače 4/4, 6/4, 6/6, in 8/8.

koda	kontakti	pakiranje	barva
T40/25010	6/4	5	bež
T40/25100	6/6	5	bež
T40/25110	8/8	5	bež

Telefonski adapter s tremi mikrovrtičnicami.

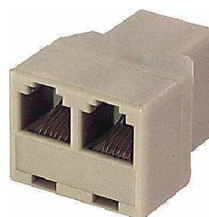

Primeren za deljenje linij telefonov, faxov, ISDN telefonov, brezžičnih telefonov, modemov,....

Za mikrovrtikače 4/4, 6/4, 6/6 in 8/8.

koda	kontakti	pakiranje	barva
T40/25500	6/4	5	bež
T40/25520	8/8	5	bež

Telefonski adapter z enim mikrovrtikačem in dvema mikrovrtičnicama.

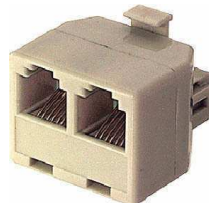

Primeren za deljenje linij telefonov, faxov, ISDN telefonov, brezžičnih telefonov, modemov,....

Za mikrovrtikače 4/4, 6/4, 6/6 in 8/8.

koda	kontakti	pakiranje	barva
T40/26000	6/4	5	bež
T40/26020	8/8	5	bež

TELEFONSKI RAZDELILNIK 5 MESTNI

Telefonski razdelilnik 5 mestni, z mikrovrtičnicami 6/4.

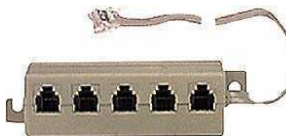

Primeren za deljenje telefonske linije na več telefonov. Vzporedna vezava.

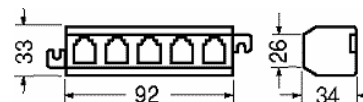

koda	kontakti	pakiranje	barva
T40/26300	6/4	5	bež

VEZICE

Veziče pakirane po 100 kosov.

Material: poliamid PA66
Delovna temperatura: od -40°C do +85°C.
Odlična obstojnost na masti, olja, čistila, UV žarke,....
So negorljive. V beli in črni barvi. Klešča za zategovanje vezic artikel: O5401

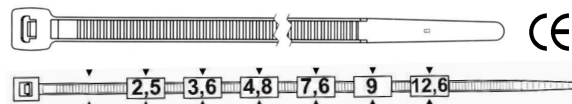

koda	dolžina	širina	barva	pak.
O080	80mm	2,5mm	bela	100
O100	100mm	2,5mm	bela	100
O140	140mm	2,5mm	bela	100
O140X3.6	140mm	3,6mm	bela	100
O160	160mm	2,5mm	bela	100
O160X4.8	160mm	4,8mm	bela	100
O200X2.5	200mm	2,5mm	bela	100
O200	200mm	3,6mm	bela	100
O200X4.8	200mm	4,8mm	bela	100
O290	290mm	3,6mm	bela	100
O290X4.8	290mm	4,8mm	bela	100
O360	360mm	4,8mm	bela	100
O360X7.6	360mm	7,6mm	bela	100
O430	430mm	4,8mm	bela	100
O530	530mm	9mm	bela	100
O1000	1000mm	12,6mm	bela	100

O080Č	80mm	2,5mm	črna	100
O100Č	100mm	2,5mm	črna	100
O140Č	140mm	2,5mm	črna	100
O140X3.6Č	140mm	3,6mm	črna	100
O160Č	160mm	2,5mm	črna	100
O160X4.8Č	160mm	4,8mm	črna	100
O200X2.5Č	200mm	2,5mm	črna	100
O200Č	200mm	3,6mm	črna	100
O200x4.8Č	200mm	4,8mm	črna	100
O290Č	290mm	3,6mm	črna	100
O290X4.8Č	290mm	4,8mm	črna	100
O360Č	360mm	4,8mm	črna	100
O360x7.6Č	360mm	7,6mm	črna	100
O430Č	430mm	4,8mm	črna	100
O530Č	530mm	9mm	črna	100
O1000Č	1000mm	12,6mm	črna	100

VEZICE PAKIRANE PO 20 KOSOV

Veziče pakirane po 20 kosov.

Material: poliamid PA66
Delovna temperatura: od -40°C do +85°C.
Odlična obstojnost na masti, olja, čistila, UV žarke,....
Negorljive. V beli in črni barvi.
Klešča za zategovanje vezic tip O5401

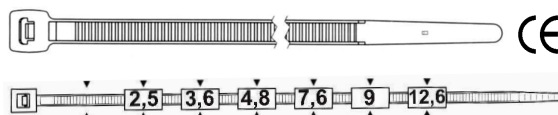

koda	dolžina	širina	barva	pak.
O098-20	98mm	2,5mm	bela	20
O140-20	140mm	3,6mm	bela	20
O200-20	200mm	3,6mm	bela	20
O290-20	290mm	4,8mm	bela	20
O098Č-20	98mm	2,5mm	črna	20
O140Č-20	140mm	3,6mm	črna	20
O200Č-20	200mm	3,6mm	črna	20
O290Č-20	290mm	4,8mm	črna	20

VEZICE BARVNE

Veziče barvne pakirane po 100 kosov.

Material: poliamid PA66
Barve: **PLAVA, RDEČA, RUMENA, ZELENA.**
Delovna temperatura: od -40°C do +85°C.
Odlična obstojnost na masti, olja, čistila, UV žarke,....
So negorljive. Klešča za zategovanje vezic artikel: O5401

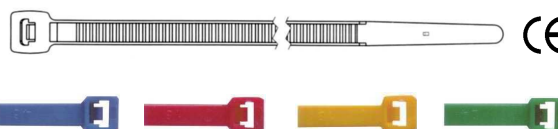

koda	dolžina	širina	barva	pak.
O140PL	140mm	3,6mm	plava	100
O200PL	200mm	3,6mm	plava	100
O140RD	140mm	3,6mm	rdeča	100
O200RD	200mm	3,6mm	rdeča	100
O140RU	140mm	3,6mm	rumena	100
O200RU	200mm	3,6mm	rumena	100
O140ZE	140mm	3,6mm	zelena	100
O200ZE	200mm	3,6mm	zelena	100

VEZICE ZA NA PANEL

Veziče za pritrjevanje na panel.

Material: poliamid PA66
Maksimalna debelina panelne plošče: 2mm
Luknja na panelu: Ø 4mm



koda	dolžina	širina	barva	pak.
OP130	130mm	3,2mm	bela	100

VEZICE Z UŠESOM

Veziče z ušesom za utrjevanje, pakirane po 100 kosov.

Material: poliamid 6.6
Delovna temperatura: od -40°C do +85°C.
Odlična obstojnost na masti, olja, čistila, UV žarke,....



koda	dolžina	širina	Ø ušesa	barva	pak.
OO150	150mm	3,6mm	4,2mm	bela	100
OO300	300mm	4,8mm	5,5mm	bela	100

VEZICE ZA VEČKRATNO ODPIRANJE

Veziče za večkratno odpiranje, pakirane po 100 kosov.

Z enostavnim pritiskom na sprožilec, se spet odprejo.
Delovna temperatura: od -40°C do +85°C.
Vzdržljivost: 22Kg

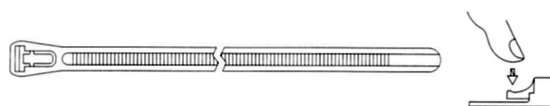

koda	dolžina	širina	barva	pak.
OVZ150	150mm	7,6mm	bela	100
OVZ200	200mm	7,6mm	bela	100
OVZ250	250mm	7,6mm	bela	100
OVZ370	370mm	7,6mm	bela	100

VEZICE VELIKE NOSILNOSTI

Veziče z dvojno ploščato glavo, velike nosilnosti.

Material: poliamid PA66
Delovna temperatura: od -40°C do +85°C.
Odlična obstojnost na masti, olja, čistila, UV žarke,....
Kleščica za zategovanje vezic artikel: O5401
Minimalna nosilnost: 60Kg

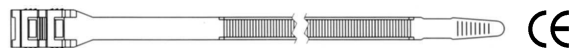

koda	dolžina	širina	barva	pak.
OE290	290mm	9mm	črna	100
OE380	380mm	9mm	črna	100

VEZICE ZA NAVTIKO

Veziče s ploščato glavo, velike nosilnosti, za posebno uporabo v slanih območjih (navtika, marikultura).

Material: poliamid PA12 z dodatki
Delovna temperatura: od -40°C do +85°C.
Odlična obstojnost na sol, masti, olja, čistila, UV žarke,....
Kleščica za zategovanje vezic artikel: O5401
Minimalna nosilnost: 51Kg



koda	dolžina	širina	barva	pak.
OF260	260mm	9mm	črna	100
OF360	360mm	9mm	črna	100

VEZICE Z NAPISNO TABLICO

Veziče z napisno tablico, za identifikacijo električnih kablov.

Velikost tablice: 20,4x9mm
Material: poliamid PA66
Na tablici lahko pišemo s flomastrom. Bele barve.



koda	dolžina	širina	barva	pak.
OT110	110mm	2,5mm	bela	100
OT210	210mm	2,5mm	bela	100

VEZICE Z NAPISNO TABLICO

Veziče z napisno tablico, za identifikacijo električnih kablov.

Velikost tablice: 13x28mm
Material: poliamid PA66
Na tablici lahko pišemo s flomastrom. Bele barve.



koda	dolžina	širina	barva	pak.
OU190	190mm	4,8mm	bela	100
OU270	270mm	4,8mm	bela	100

VEZICE Z NAPISNO TABLICO

Veziče z napisno tablico, za identifikacijo električnih kablov.

Velikost tablice: 25,4x8mm
Material: poliamid PA66
Na tablici lahko pišemo s flomastrom. Bele barve.

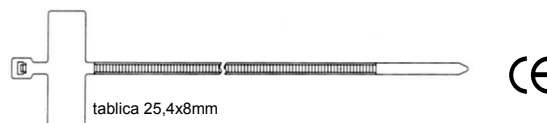

koda	dolžina	širina	barva	pak.
OS100	100mm	2,5mm	bela	100
OS200	200mm	2,5mm	bela	100

VEZICE VZDRŽLJIVE NA TOPLOTO

Veziče vzdržljive na visoke temperature

Možna uporaba pri stalni temperaturi 130°C, za kratek čas do 160°C!

Material: poliamid PA66 z dodatki
Standardna barva je rdeča (RAL 3003).
Druge barve in dolžine po naročilu.

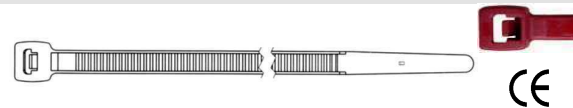

koda	dolžina	širina	barva	pak.
OVT100	100mm	2,5mm	rdeča	5000
OVT200	200mm	3,6mm	rdeča	5000
OVT360	360mm	4,8mm	rdeča	4000

VEZICE VZDRŽLJIVE NA UV ŽARKE

Veziče posebno vzdržljive na UV žarke.

Idealne za zunanjo montažo, kjer je pomembna izredna odpornost na UV žarke in nizke temperature.

Material: poliamid 66 UV z dodatki
Delovna temperatura: od -40°C do +80°C.
Zelene barve (RAL 6005).

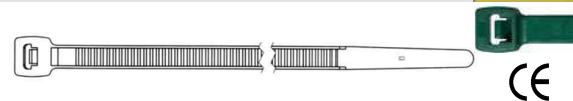

koda	dolžina	širina	barva	pak.
OVU100	140mm	3,6mm	zelena	5000
OVU200	200mm	4,8mm	zelena	5000
OVU250	250mm	7,6mm	zelena	5000

UNO elektronika d.o.o.

Dolenja vas 1b
6224 Senožeče

tel. 05 76-56-140
fax. 05 76-56-141
www.unoelektronika.si
e-mail: uno.elektronika@siol.net

Po naročilu so dobavljive veziče in pritrjevalni elementi, ki niso prisotni v tem katalogu!!

SAMOLEPLJIVE PLOŠČICE

Samolepljive ploščice za pritrjevanje vezic.
Bele in črne barve, z dvema režama za fiksiranje vezic.
Na sredini je luknja, z možnostjo dodatnega fiksiranja ploščice z vijakom.
Z dvostranskim lepilnim trakom.

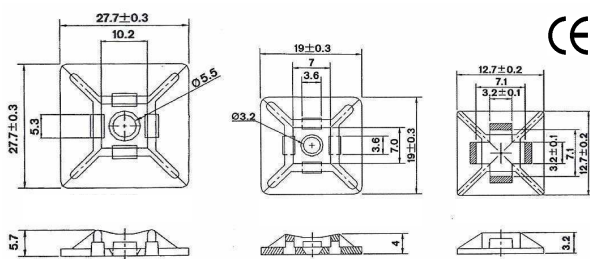

koda bela barva	koda črna barva	dimenzija ploščice	za širino vezice do	pak.
OPL12B	OPL12Č	12x12mm	3,2mm	100
OPL19B	OPL19Č	19x19mm	3,6mm	100
OPL27B	OPL27Č	27x27mm	5,3mm	100

SAMOLEPLJ. PLOŠČICE Z LOKOM

Samolepljive ploščice z lokom za pritrjevanje kablov.
Bele in črne barve. Možnost kasnejšega odpiranja.
Z dvostranskim lepilnim trakom.

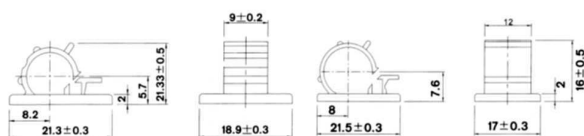

CE

koda bela barva	koda črna barva	dimenzija ploščice	objem do fi	pak.
OPL9750	OPL9751	21,5x17mm	8-9mm	100
OPL9760	OPL9761	21,5x19mm	9-12mm	100

ZIDNI VLOŽEK ZA FIKSIRANJE VEZIC

Zidni vložek za fiksiranje vezic.
Za vezice do širine 9mm.
Za fiksiranje cevi, šope kablov, nadometne kanale, ...
Izvrtna v betonu, opeki, votlaku, gips plošči, lesu je 8mm.
Vložek zabijemo v izvrtno in skozi okoli vstavimo vezico.
Hitro in poceni fiksiranje!

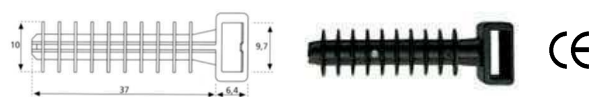

koda	barva	pakiranje
OPL9771	črna	100 kos

NOSILEC VEZIC Z VIJAČENJEM

Nosilec vezic z vijačenjem.
Bele barve. Pakirano po 100 kosov.
Z dvema režama za fiksiranje vezice.
Na sredini ploščice je luknja za vijak.

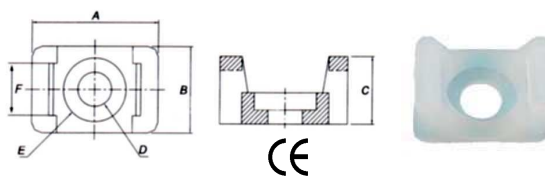

koda	barva	A	B	C	D	E	F
OPL9700	BELA	15mm	9,5mm	7,2mm	3,7mm	7,0mm	4,8mm
OPL9710	BELA	22mm	16mm	9,7mm	5,0mm	9,6mm	9mm
OPL9701	ČRNA	15mm	9,5mm	7,2mm	3,7mm	7,0mm	4,8mm
OPL9711	ČRNA	22mm	16mm	9,7mm	5,0mm	9,6mm	9mm

SAMOLEPLJIVA PLOŠČICA ZA FLAT KABEL

Samolepljiva ploščica za ploščate kable.
Material: PVC
Z dvostranskim lepilnim trakom.

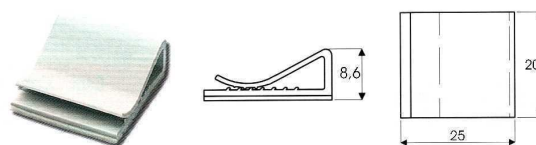

koda	barva	dimenzija	pakiranje
OPL9790	bela	20x26x9,6mm	100



UNO elektronika d.o.o.

Dolenja vas 1b
6224 Senožeče

tel. 05 76-56-140
fax. 05 76-56-141
www.unoelektronika.si
e-mail: uno.elektronika@siol.net

Po naročilu so dobavljive vezice in pritrjevalni elementi, ki niso prisotni v tem katalogu!!

SPIRALA IZ POLIETILENA

Spirala iz polietilena.

Uporabna za zaščito kablov in cevi. Omogoča ovijanje, že položenih kablov. V beli in črni barvi.
Maksimalna delovna temperatura: +85°C



koda bela barva	koda črna barva	notranji premer spirale	maks. premer	pakiranje v vrečki
OSP06B	OSP06Č	6mm	40mm	25m
OSP09B	OSP09Č	9mm	50mm	25m
OSP12B	OSP12Č	12mm	70mm	25m
OSP15B	OSP15Č	15mm	100mm	25m
OSP20B	OSP20Č	20mm	130mm	20m

STOJALO ZA VEZICE

Stojalo za vezice.

Praktično in elegantno, omogoča self-servis.
Stojalo je prazno (brez vezic).



OVZX1



OVZX2

Koda	opis stojala	dimenzije	pak.
OVZX1	talno, na kolesčkih	200x80cm	1
OVZX2	za na pult, vrtljivo	H=80cm	1

KLEŠČA ZA ZATEGOVANJE VEZIC

Klešča za zategovanje vezic.

Avtomatsko orodje iz jekla, ki omogoča zategovanje in rezanje vezic z eno samo operacijo.
Moč zategovanja je nastavljiva. Za vezice do širine 4,8mm.



koda

pakiranje



UNO elektronika d.o.o.

Dolenja vas 1b
6224 Senožeče

tel. 05 76-56-140

fax. 05 76-56-141

www.unoelektronika.si

e-mail: uno.elektronika@siol.net

Po naročilu so dobavljive vezice in pritrjevalni elementi, ki niso prisotni v tem katalogu!!

ANTENSKI TV KONEKTORJI

TV VTIKAČ IN VTIČNICA RAVNA ZA ANTENSKI KABEL



koda	konektor	pak.	pritrditev kabla
ASPECM	vtikač	50	z vijakom
ASPECF	vtičnica	50	z vijakom

TV VTIKAČ RAVNI ZA ANTENSKI KABEL, OKLOPLJEN

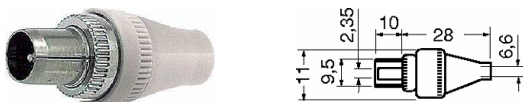

koda	konektor	pak.	pritrditev kabla
AFSP5	vtikač	50	na pritisk

VTIKAČ IN VTIČNICA TV KOTNA ZA ANTENSKI KABEL



koda	maks. fi kabla	pak.	pritrditev kabla
ASPECM90	7mm	25	z vijaki
ASPECF90	7mm	25	z vijaki

KOAKSIALNA SPOJKA ZA ANTENSKI KABEL



koda	maks. fi kabla	pak.	pritrditev kabla
AFGC1	7mm	10	z vijaki

KONEKTOR ADAPTER ZA TV VTIKAČE / VTIČNICE



koda	adapter	pak.
A4/1670	vtičnica / vtičnica	10
A4/1672	vtikač / vtikač	10

UNO elektronika d.o.o.
Dolenja vas 1b, 6224 Senožeče

www.unoelektronika.si
tel. 05 76-56-140 fax. 05 76-56-141
mail: uno.elektronika@siol.net

DELILNIKI TV SIGNALA

ANTENSKI DELILNIK TV SIGNALA, OKROGLA IZVEDBA

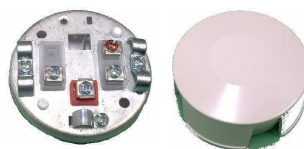

Induktivni delilnik
Impedanca: 75 Ohm

Na eni sponki, je možen
prehod napetosti.

koda	izhodi	pak.	dušenje 5 - 900Mhz
ASDIN2	2	1	maks. -3,5dB
ASDIN3	3	1	maks. -4dB
ASDIN4	4	1	maks. -6dB

ANTENSKI DELILNIK TV SIGNALA Z F KONEKTORJI



Induktivni delilnik z F
konektorji

Impedanca: 75 Ohm



koda	izhodi	frekv. območje	dušenje	pak.
AIFV2	2	5 - 900Mhz	maks. -5dB	1
		900 - 2400Mhz	maks. -8dB	1
AIFV3	3	5 - 1000Mhz	maks. -6dB	1
AIFV4	4	5 - 1000Mhz	maks. -8dB	1
AIFV6	6	5 - 2400Mhz	maks. -12dB	1
AIFV8	8	5 - 2400Mhz	maks. -14dB	1

ANTENSKI DELILNIK TV SIGNALA, T IZVEDBA



Oklopljen induktivni TV
delilnik z TV konektorji.
Impedanca: 75 Ohm
Dušenje 5 - 900Mhz
maks. -3,5dB.

koda	izhodi	konektorji	pak.
ASSPCTRIS	2	vtikač / 2 vtičnici	10
ASSPCTRIS2	2	vtičnica / 2 vtikača	10

ANTENSKI PREKLOPNIK TV SIGNALA

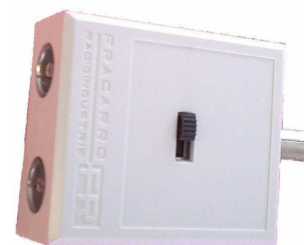

Oklopljen preklopnik TV
signala z TV konektorji.
Preklop z drsnim
stikalom.
Impedanca: 75 Ohm
Dušenje 5 - 900Mhz
maks. -0,5dB.

koda	izhoda	konektorji	pak.
AFMPDEV	2	vtikač / 2 vtičnici	1

MEŠALCI ZA NA DROG Z DVEMA VHODOMA



Enokanalni mešalec za na drog z dvema vhodoma in enim izhodom. Maksimalni Ø droga je 50mm.
1° vhod omogoča prehod enim izbranim kanalom K_1 (med 2 in 69 kanalom) s prehodnim dušenjem $-2dB$.
2° vhod omogoča prehod celotnega TV pasa (2:69K), razen kanala K_1 , ki je dušen $-35dB$, + prehod napajanja DC.

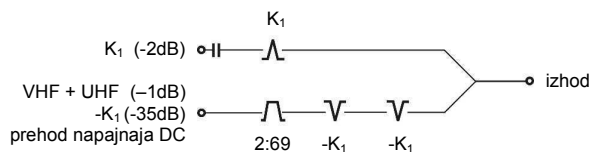

koda UNO	koda MITAN	vhod 1 K_1	vhod 2 $-K_1$
AM0465	002=6	6K (-2dB)	2 : 69K (-1dB) +DC, dušen 6K(-35dB)
AM0464	002=10	10K (-2dB)	2 : 69K (-1dB) +DC, dušen 10K(-35dB)
AM0461	002=38	38K (-2dB)	2 : 69K (-1dB) +DC, dušen 38K(-35dB)
AM0463	002=55	55K (-2dB)	2 : 69K (-1dB) +DC, dušen 55K(-35dB)
AM0462	002=64	64K (-2dB)	2 : 69K (-1dB) +DC, dušen 64K(-35dB)

Ostali kanali po naročilu...

Dvokanalni mešalec za na drog z dvema vhodoma in enim izhodom. Maksimalni Ø droga je 50mm.
1° vhod omogoča prehod dvema izbranimi kanaloma K_1 in K_2 (med 2 in 69 kanalom) s prehodnim dušenjem $-3dB$.
2° vhod omogoča prehod celotnega TV pasa (2:69K), razen kanalov K_1 in K_2 ki sta dušena $-20dB$, + prehod napajanja DC.

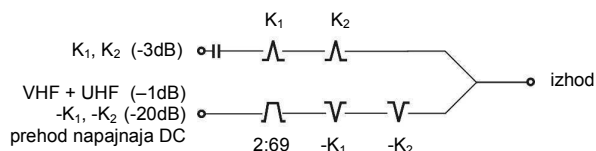

koda UNO	koda MITAN	vhod 1 K_1 in K_2	vhod 2 $-K_1$ in $-K_2$
AM0422	014-55-69	55-69K (-3dB)	2 : 69K (-1dB) +DC, dušena 55K in 69K (-20dB)
AM0401	014-38-67	38-67K (-3dB)	2 : 69K (-1dB) +DC, dušena 38K in 67K (-20dB)
AM040	014=38=67	38-67K (-3dB)	2 : 69K (-1dB) +DC, dvojno dušena 38K in 67K (-35dB)
AM042	014=27-41	27-41K (-3dB)	2 : 69K (-1dB) +DC, dušena 27K in 41K (-20dB)

Ostali kanali po naročilu...

Trokanalni mešalec za na drog z dvema vhodoma in enim izhodom. Maksimalni Ø droga je 50mm.
1° vhod omogoča prehod trim izbranim kanalom K_1 , K_2 in K_3 (med 2 in 69 kanalom) s prehodnim dušenjem $-3dB$.
2° vhod omogoča prehod celotnega TV pasa (2:69K), razen kanalov K_1 , K_2 in K_3 ki so dušeni $-20dB$, + prehod napajanja DC.

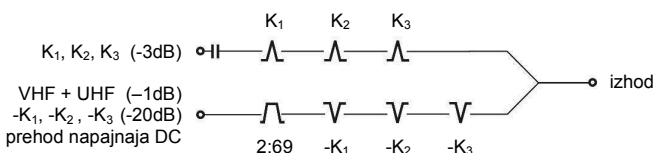

koda UNO	koda MITAN	vhod 1 K_1, K_2, K_3	vhod 2 $-K_1, -K_2, -K_3$
AM043	104-38-63-67	38-63-67K (-3dB)	2 : 69K (-1dB) +DC, dušeni 38K, 63K in 67K (-20dB)
AM0430	104=38=63-67	38-63-67K (-3dB)	2 : 69K (-1dB) +DC, dušeni 38K in 63K (-35dB), 67K -20dB
AM0433	104-6-27-41	6-27-41K (-3dB)	2 : 69K (-1dB) +DC, dušeni 6K, 27K in 41K (-20dB)
AM0434	104-11-29-39	11-29-39K (-3dB)	2 : 69K (-1dB) +DC, dušeni 11K, 29K in 39K (-20dB)
AM045	104-27-41-61	27-41-61K (-3dB)	2 : 69K (-1dB) +DC, dušeni 27K, 41K in 61K (-20dB)
AM044	104-60-63-67	60-63-67K (-3dB)	2 : 69K (-1dB) +DC, dušeni 60K, 63K in 67K (-20dB)
AM0435	104-38-60-67	38-60-67K (-3dB)	2 : 69K (-1dB) +DC, dušeni 38K, 60K in 67K (-20dB)
AM0436	104-21-25-33	21-25-33K (-3dB)	2 : 69K (-1dB) +DC, dušeni 21K, 25K in 33K (-20dB)

Ostali kanali po naročilu...

Štirikanalni mešalec za na drog z dvema vhodoma in enim izhodom. Maksimalni Ø droga je 50mm.
1° vhod omogoča prehod štirim izbranim kanalom K_1 , K_2 , K_3 , in K_4 (med 2 in 69 kanalom) s prehodnim dušenjem $-3dB$.
2° vhod omogoča prehod celotnega TV pasa (2:69K), razen kanalov K_1 , K_2 , K_3 in K_4 ki so dušeni $-20dB$, + prehod napajanja DC.

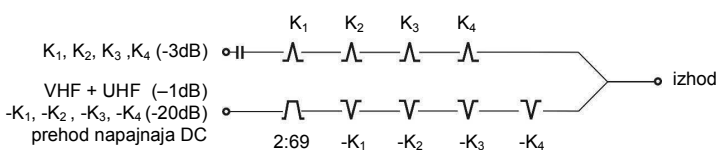

koda UNO	koda MITAN	vhod 1 K_1, K_2, K_3, K_4	vhod 2 $-K_1, -K_2, -K_3, -K_4$
AM053	113-6-27-41-61	6-27-41-61K (-3dB)	2 : 69K (-1dB) +DC, dušeni 6K, 27K, 41K in 61K (-20dB)
AM0531	113-11-29-39-68	11-29-39-68K (-3dB)	2 : 69K (-1dB) +DC, dušeni 11K, 29K, 39K in 68K (-20dB)

OJAČEVALNIKI 

ANTENSKI MATERIAL MITAN

Ojačevalniki za na drog z enim vhodom in enim izhodom, z F konektorji. Maksimalni Ø droga je 50mm.

III + UHF band ojačano +12dB
dušen FM (-20dB)
nastavljiv prehod napajanja DC
z notranjim mostičkom

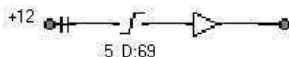

Izhod:
+110dBμV
Napajanje:
12V 30mA

koda UNO koda MITAN ojačanje
AM0073 IABPA **12dB**



III + UHF band ojačano 4:24dB
dušen FM (-20dB)
nastavljiv prehod napajanja DC
z notranjim mostičkom

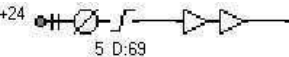

Izhod:
+110dBμV
Napajanje:
12V 45mA

koda UNO koda MITAN ojačanje nastavljivo
AM00823 IADPB **4:24dB**



Predojačevalnik nizkošumni < 1dB z GaSaFet tranzistorji, z F konektorji.

UHF band ojačano 17dB

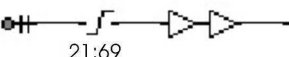

Izhod:
+110dBμV
Napajanje:
5 - 24V 50mA

koda UNO koda MITAN ojačanje
AM0089 EU102 **UHF +17dB**



VHF nastavljivo ojačanje +25dB

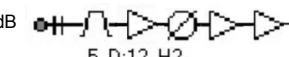

Izhod:
+110dBμV

UHF nastavljivo ojačanje +36dB

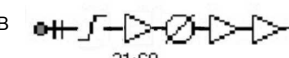

Napajanje:
5 - 24V 90mA

koda UNO koda MITAN ojačanje
AM00892 EU201 **VHF +25dB, UHF +36dB**

VHF nastavljivo ojačanje +30dB

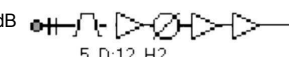

Izhod:
+110dBμV

UHF nastavljivo ojačanje +36dB

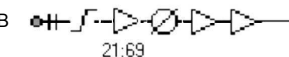

Napajanje:
5 - 24V 110mA

UHF nastavljivo ojačanje +36dB

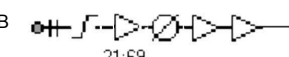

koda UNO koda MITAN ojačanje
AM00893 EU303 **VHF +30dB, UHF +36dB, UHF +30dB**



UHF band ojačano 12dB

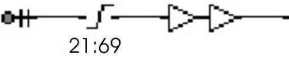

Izhod:
+100dBμV
Napajanje:
12V 50mA

koda UNO koda MITAN ojačanje šum
AM0087 SAA99 **UHF +12dB** **0,5dB**

Predojačevalnik primeren za vgradnjo v ISKRA antene serije DTX

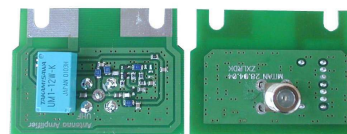

Ojačevalniki za na drog z enim vhodom in enim izhodom. Maksimalni Ø droga je 50mm.

III + UHF band ojačano +34dB
dušen FM (-20dB)

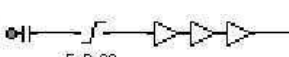

Izhod:
+115dBμV
Napajanje:
12V 110mA

koda UNO koda MITAN ojačanje
AM0081 IAG00 **III+UHF +34dB**



NAPAJALNIKI IN FILTRI 

ANTENSKI MATERIAL MITAN

Ojačevalnik z enim vhodom in enim izhodom z vgrajenim 220V napajalnikom . Priključki na F konektorje.

VHF + UHF ojačano 2:22dB
dušen FM (-20dB)

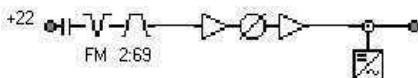

Izhod:
+115dB μ V
Napajanje:
220/230Vac



koda UNO	koda MITAN	ojačanje nastavljivo	izhodni nivo
AM0084	SBD01	2:22dB	115dB μ V

Antenski napajalnik iz 220V na 12V. Zaščiten proti kratkemu stiku in pregrevanju. Z IC regulatorjem. Negorljiv.

koda UNO	koda MITAN	izhod	opomba
AM110	AL200	12V 100mA	z led diodo
AM112	AL100	12V 100mA	brez led diode
AM120	AL300	12V 200mA	z led diodo
AM115	AK200	12V 100mA	z F konektorji in LED diodo
AM130	AL400	12V 300mA	z led diodo



Nastavljiv nepropustni filter za UHF z dvema trimerjema. Montaža za na drog. Maksimalni \varnothing droga je 50mm.

Prehod VHF in UHF (-1dB)
prehod napajanja DC
2 nastavljiva trimerja na UHF
vsak duši od -10 do -15dB

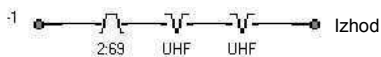

Izhod

koda UNO	koda MITAN
AM091	50700



Nastavljiv nepropustni filter za UHF s štirimi trimerji. Montaža za na drog. Maksimalni \varnothing droga je 50mm.

Prehod VHF in UHF (-1dB)
prehod napajanja DC
4 nastavljivi trimerji na UHF
vsak duši od -10 do -15dB



Izhod

koda UNO	koda MITAN
AM092	34500



Nastavljiv nepropustni filter za UHF z osmimi trimerji (4 nastavljive sekcije). Montaža za na drog.

Prehod VHF in UHF (-1dB)
prehod napajanja DC
s 4 nastavljivimi trimerji
nastavimo kanal, z ostalimi 4 pa
dušenje od -5 do -15dB

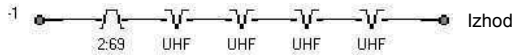

Izhod

koda UNO	koda MITAN
AM090	FM200



Škatla prazna s priborom za montažo na drog. Maksimalni \varnothing droga je 50mm.

Škatla mini, za
naprave z F konektorji
73x37x92mm



koda UNO: **AM558**
koda MITAN:00100

Škatla mala
105x75x43mm



AM559
00101

Škatla srednja
110x90x45mm



AM560
00102

Škatla velika
140x120x50mm



AM561
00103

DISEqC 2.0 



Preklopnik DISEqC 2.0

Kompatibilen z DISEqC 1.0
Razklop med vhoda: 40dB
Vhodno območje: 900 : 2150Mhz
Maksimalna poraba: 25mA
Prehod napajanja max: 0,5A
Ohišje: kovinsko 61x47x28mm
Priključki: F vtičnice

koda UNO	koda MITAN	opomba
AM302	S1H00	brez škatle za zunanjo montažo
		za zunanjo montažo je potrebno posebej naročiti škatlo AM558

MIX / DEMIX SAT-TV 

Mix/demix SAT/TV po enem samem kablu. Frekvenčno območje od 40 do 2400MHz.

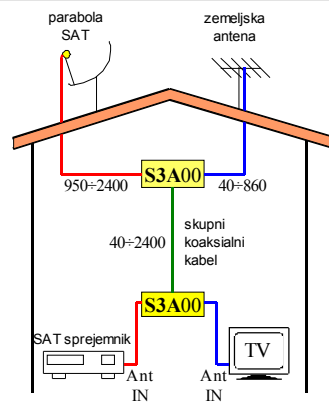

koda UNO	koda MITAN	dušenje TV	dušenje SAT	razklop
AM076	S3A00	1,5dB	2,5dB	>45dB

ANTENSKI DELILNIKI IN ODCEPNIKI 

Antenski večvejni delilniki . Frekvenčno območje od 5 do 870MHz. Prehod napajanja CC na enem izhodu .

koda UNO	koda MITAN	št. Izhodov	dušenje	razklop med izhodi
AM070	DV200	2	-4dB	-20dB
AM071	DV300	3	-6dB	-22dB

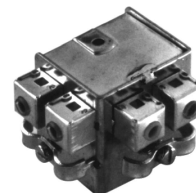

Antenski odcepnik. Frekvenčno območje od 5 do 870MHz. Razklop >20dB

koda UNO	koda MITAN	št. Izhodov	dušenje odcepa	dušenje prehoda
AM073	D1P00	1	-7,5dB	-2dB



UNO elektronika d.o.o.
Dolenja vas 1b, 6224 Senožeče
tel. 05 76-56-140 fax. 05 76-56-141

Po naročilu dobavljivi vsi artikli od MITAN-a ki niso prisotni v tem katalogu!!!
Pokličite za dodatna pojasnila!

ANTENSKI MONTAŽNI PRIBOR

Nosilec droga za na dimnik, iz pocinkane pločevine. Za drogeve premera od 25 do 50mm. Odmik od dimnika 100mm.

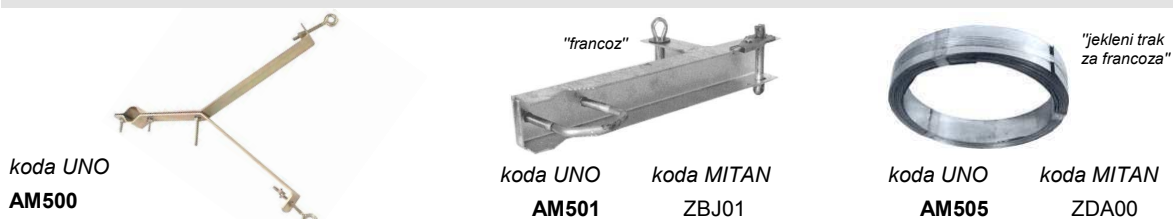

Nosilec droga z vložkom fi 16mm za v beton. Za drogeve premera 25 do 50mm. Odmik od zida 200mm.

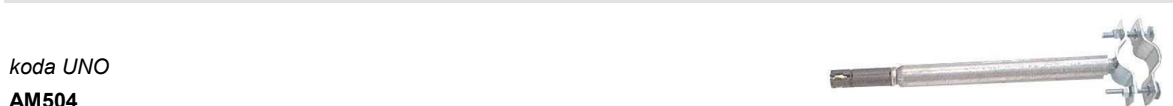

Nosilec droga nastavljiv, iz pocinkane pločevine debeline 3mm. Za drogeve premera 25 do 50mm. Odmik od zida nastavljiv od 300 do 450mm. Dimenzije pritrdilne plošče: 100x140x3mm.



Nosilec SAT parabole, iz pocinkane pločevine. Premer cevi Ø40mm, višine 400mm. Odmik od zida 480mm. Dimenzije pritrdilne plošče: 200x135x4mm.

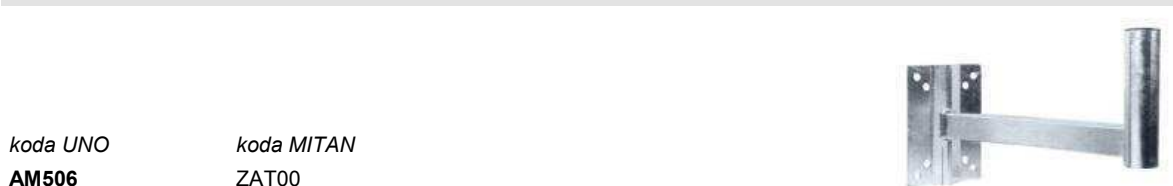

Objemka za sidranje droga, iz pocinkane pločevine. Za drogeve premera od 25 do 50mm.



Nosilec za anteno prečni, (za vertikalno polarizacijo) iz pocinkane pločevine. Premer cevi je 25mm. Za drogeve premera od 25 do 50mm.

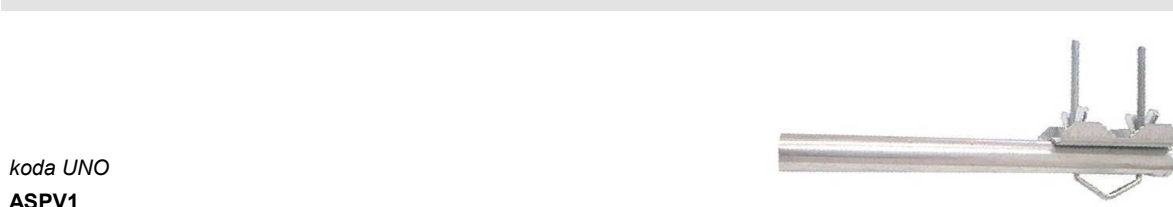

Nosilec za logaritmično anteno prečni, (za vertikalno polarizacijo) iz pocinkane pločevine. Za drogeve premera od 25 do 50mm.



RELEJI

2 polni rele za na tiskano vezje ali podnožje, raster 5mm.
Dvopolni preklopni kontakti nosilnosti 8A/250VAC. Za podnožje E22/2400.

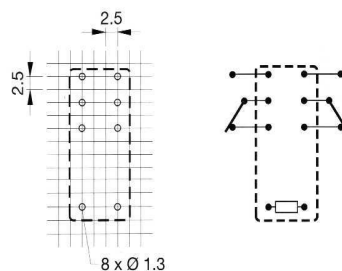
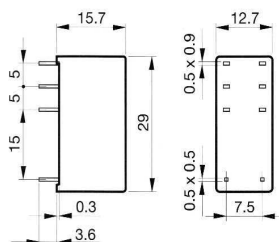
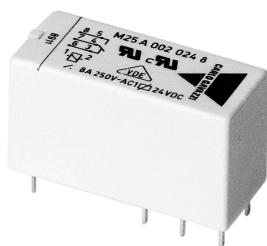

koda UNO	koda proizvajalca	napetost tuljave	št. polov	nosilnost kontaktov	pakiranje
E22/2006	GOODSKY EMI-SS-206D	6 VDC	2	8A/250 VAC	20
E22/2012	VEGHA L08A02-12VDC	12 VDC	2	8A/250 VAC	25
E22/2024	VEGHA L08A02-24VDC	24 VDC	2	8A/250 VAC	20
E22/2024AC	C. GAVAZZI M25A002 A24 08	24 VAC	2	8A/250 VAC	20
E22/2230	VEGHA L08A02-230AC	230 VAC	2	8A/250 VAC	25

1 polni rele za na tiskano vezje ali podnožje, raster 5mm.
Enopolni preklopni kontakti nosilnosti 16A/250VA. Za podnožje E22/2400.

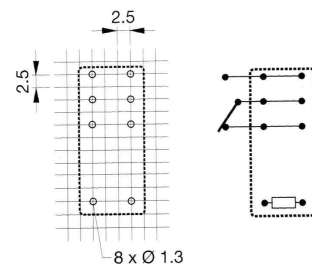
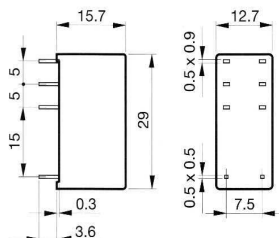
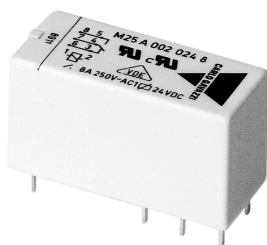

koda UNO	koda proizvajalca	napetost tuljave	št. polov	nosilnost kontaktov	pakiranje
E22/1012	C. GAVAZZI M25A00101216	12 VDC	1	16A/250 VAC	20
E22/1024	C. GAVAZZI M25A00102416	24 VDC	1	16A/250 VAC	20
E22/1230	SCHRACK RT314730	230VAC	1	16A/250 VAC	20

1 polni močnostni rele za na tiskano vezje ali podnožje, raster 3,5mm.
Enopolni preklopni kontakti nosilnosti 12A/250VAC.

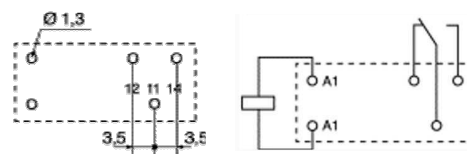
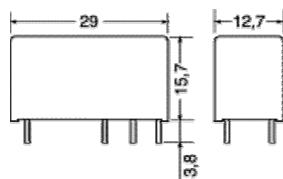

koda UNO	koda proizvajalca	napetost tuljave	št. polov	nosilnost kontaktov	pakiranje
E4/7513	GOODSKY EMI-SS-112D	12 VDC	1	12A/250 VAC	25
E4/7514	GOODSKY EMI-SS-124D	24 VDC	1	12A/250 VAC	25

UNO elektronika d.o.o.

Dolenja vas 1b
6224 Senožeče

tel. 05 76-56-140
fax. 05 76-56-141
www.unoelektronika.si
e-mail: uno.elektronika@siol.net

Po naročilu so dobavljivi tudi releji drugih znamk in oblik, ki niso prisotni v tem katalogu!!

RELEJI

1 polni rele za na tiskano vezje, raster 3,5mm.
Enopolni preklopni kontakti nosilnosti 10A/250VAC.

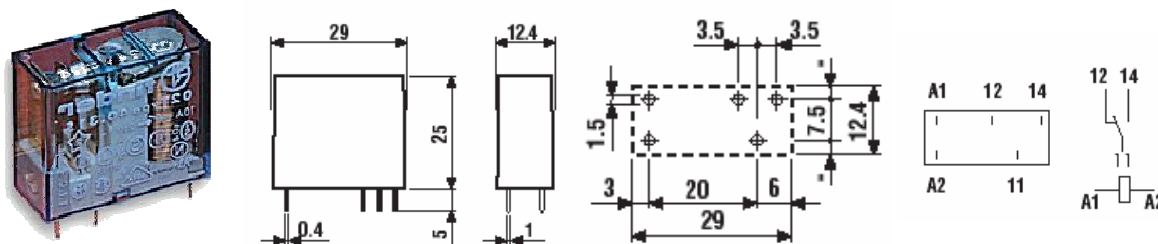

koda UNO	koda proizvajalca	napetost tuljave	št. polov	nosilnost kontaktov	pakiranje
E4/7576	/	12 VDC	1	10A/250 VAC	25
E4/7577	/	24 VDC	1	10A/250 VAC	25
E4/7576F	FINDER 40.31.7.012.0000	12 VDC	1	10A/250 VAC	1
E4/7579F	FINDER 40.31.7.048.0000	48 VDC	1	10A/250 VAC	1

2 polni rele za na tiskano vezje ali podnožje, raster 5mm.
Dvopolni preklopni kontakti nosilnosti 8A/250VAC. Za podnožje E22/2400.

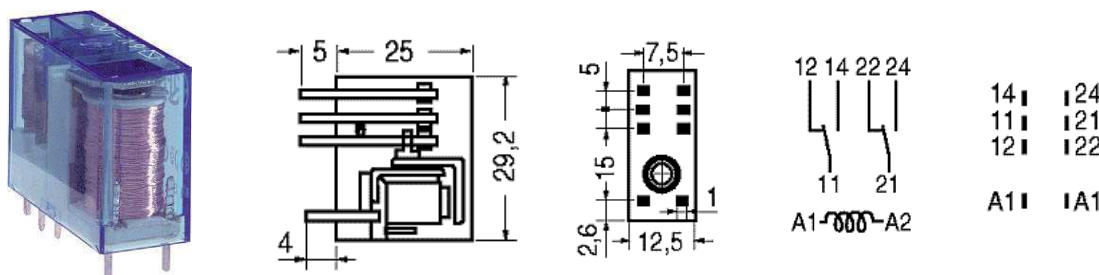

koda UNO	koda proizvajalca	napetost tuljave	št. polov	nosilnost kontaktov	pakiranje
E4/7585	/	6 VDC	2	8A/250 VAC	10
E4/7586	FINDER 40.52.7.012.0000	12 VDC	2	8A/250 VAC	10
E4/7588	FINDER 40.52.7.024.0000	24 VDC	2	8A/250 VAC	10

1 polni nizek rele za na tiskano vezje, raster 3,2mm.
Enopolni preklopni kontakti nosilnosti 8A/250VAC.

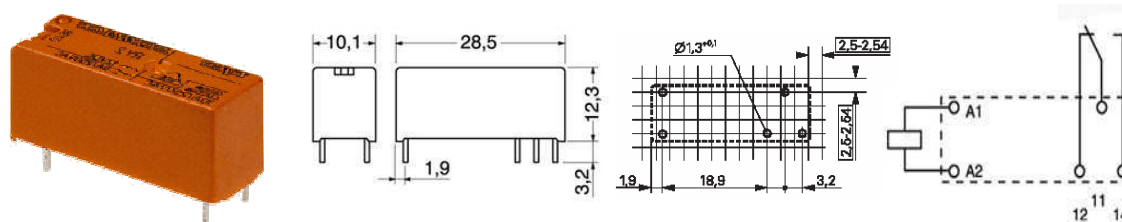

koda UNO	koda proizvajalca	napetost tuljave	št. polov	nosilnost kontaktov	pakiranje
E4/7708	SCHRACK RY211012	12 VDC	1	8A/250 VAC	20
E4/7709	SCHRACK RY211024	24 VDC	1	8A/250 VAC	20

UNO elektronika d.o.o.

Dolenja vas 1b
6224 Senožeče

tel. 05 76-56-140

fax. 05 76-56-141

www.unoelektronika.si

e-mail: uno.elektronika@siol.net

Po naročilu so dobavljivi tudi releji drugih znamk in oblik, ki niso prisotni v tem katalogu!!

RELEJI

2 polni submini rele za na tiskano vezje, raster 5,08mm.

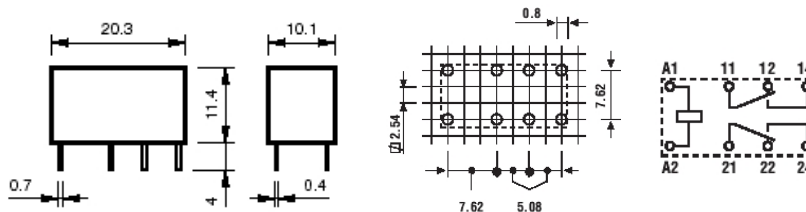
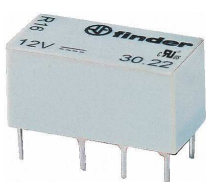

koda UNO	koda proizvajalca	napetost tuljave	št. polov	nosilnost kontaktov	pakiranje
E4/7467	GOODSKY GS-SH-212T	12VDC	2	2A/250VAC	30
E4/7467F	FINDER 30.22.7.012.	12 VDC	2	2A/250 VAC	30

1 polni submini rele za na tiskano vezje raster 7,62mm.

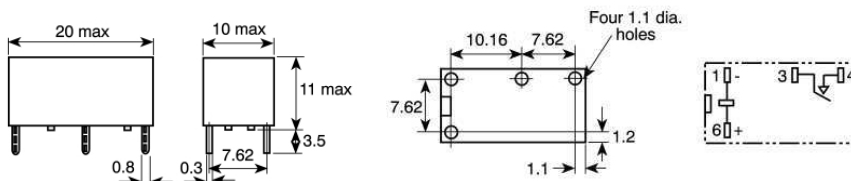
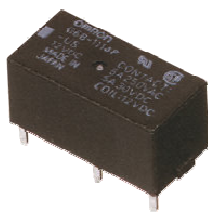

koda UNO	koda proizvajalca	napetost tuljave	št. polov	nosilnost kontaktov	pakiranje
E4/7469B	OMRON G6B-1114P-US-12DC	12 VDC	1	5A/250 VAC	1
E4/7469C	OMRON G6B-1114P-US-24DC	24 VDC	1	5A/250 VAC	1

1 polni rele mini, za na tiskano vezje.
Enopolni preklopni kontakti nosilnosti 10A/250VAC.

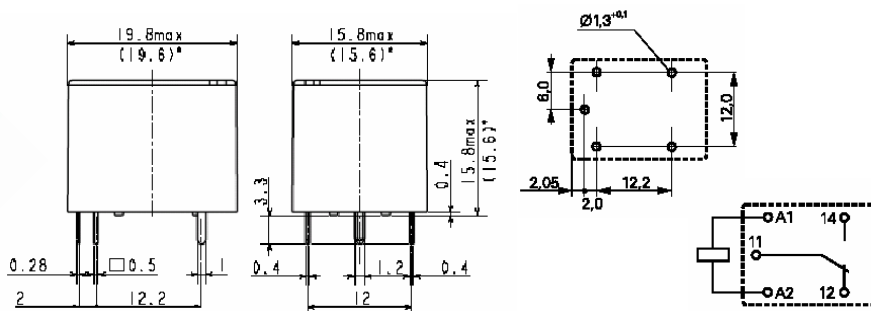

koda UNO	koda proizvajalca	napetost tuljave	št. polov	nosilnost kontaktov	pakiranje
E4/7521	TYCO T7SS5E6-5	5 VDC	1	10A/250 VAC	1
E4/7523	TYCO T7SS5E6-12	12 VDC	1	10A/250 VAC	1
E4/7525	TYCO T7SS5E6-24	24 VDC	1	10A/250 VAC	1

1 polni rele mini, za na tiskano vezje.
Enopolni preklopni kontakti nosilnosti 10A/250VAC.

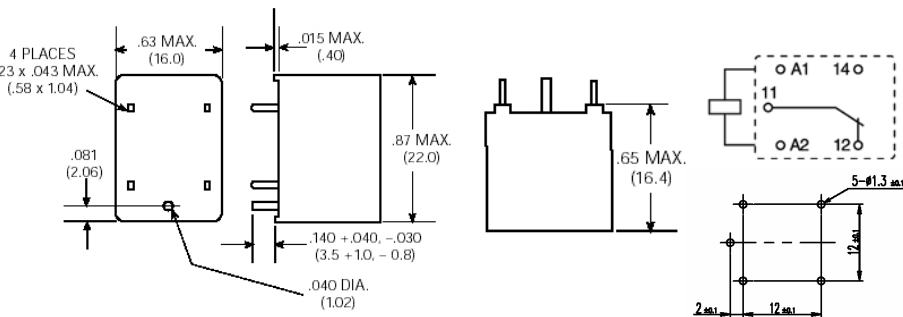
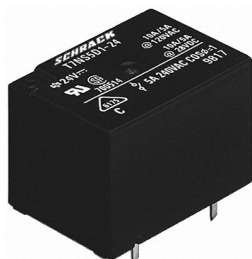

koda UNO	koda proizvajalca	napetost tuljave	št. polov	nosilnost kontaktov	pakiranje
E4/7618	TYCO T7NS5D1-12	12 VDC	1	10A/250 VAC	25
E4/7619	TYCO T7NS5D1-24	24 VDC	1	10A/250 VAC	25

RELEJI

1 polni rele za na tiskano vezje.

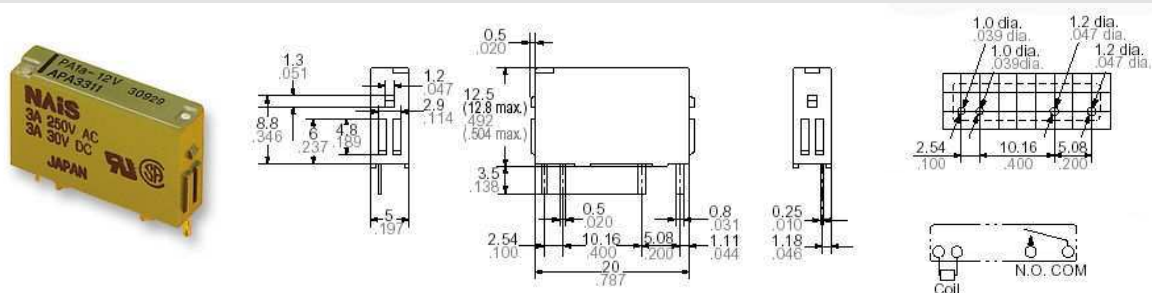

koda UNO	koda proizvajalca	napetost tuljave	št. polov	nosilnost kontaktov	pakiranje
E4/7830B	PANASONIC/NAIS PA1A-5V	5 VDC	1	5A/250 VAC	1
E4/7831B	PANASONIC/NAIS PA1A-12V	12 VDC	1	5A/250 VAC	1

1 polni horizontalni rele za na tiskano vezje, raster 5mm.

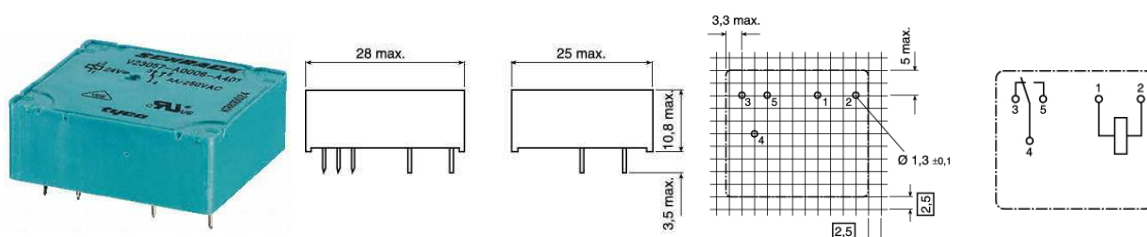

koda UNO	koda proizvajalca	napetost tuljave	št. polov	nosilnost kontaktov	pakiranje
E4/7835B	TYCO V23057-A0002-A201	12 VDC	1	8A/250 VAC	1
E4/7836B	TYCO V23057-A0006-A101	24 VDC	1	8A/250 VAC	1

RELEJI "FEME - CARLO GAVAZZI" SERIJE RMI

4 polni rele, serije RMI.

4 polni preklopni kontakti nosilnosti 5A/250VAC, 5A/30VDC z zastavico, testnim gumbom in kontrolno led lučko.
Primerni za krmilne in regulacijske naprave.
Za podnožje E22/4400.

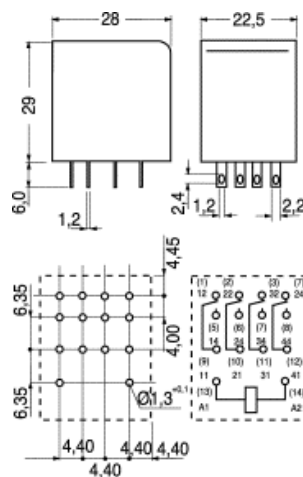
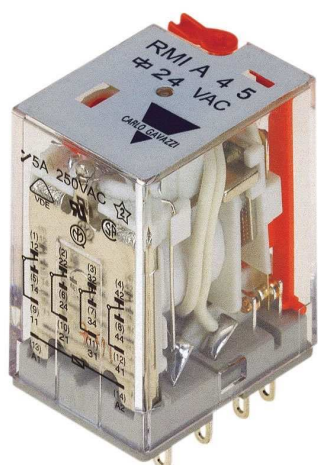

koda UNO	koda proizvajalca	napetost tuljave	št. polov	nosilnost kontaktov	pakiranje
E22/4012	C. GAVAZZI RMIA4-5012DC	12 VDC	4	5A/250 VAC	10
E22/4024	C. GAVAZZI RMIA4-5024DC	24 VDC	4	5A/250 VAC	10
E22/4024AC	C. GAVAZZI RMIA4-5024AC	24 VAC	4	5A/250 VAC	10
E22/4110	FINDER 55.34.9.110.0040	110 VDC	4	7A/250 VAC	10
E22/4230	C. GAVAZZI RMIA4-5230AC	230 VAC	4	5A/250 VAC	10

RELEJI

1 polni 50A avtomobilski rele, kontakti na faston 6,3mm
Enopolni preklopni kontakti nosilnosti 50A pri 14VDC.

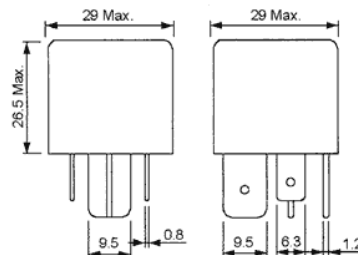
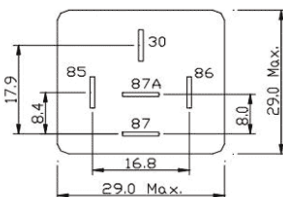
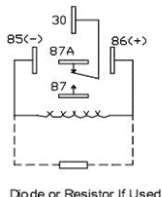

koda UNO	koda proizvajalca	napetost tuljave	št. polov	nosilnost kontaktov	pakiranje
E4/7630B	FRC2C-1 12VDC	12 VDC	1	50A/14VDC	1
E4/7631B	FRC2C-1 24VDC	24 VDC	1	50A/14VDC	1

1 polni 70A avtomobilski rele, kontakti na faston 6,3mm
Enopolni delovni kontakti nosilnosti 70A pri 14VDC.

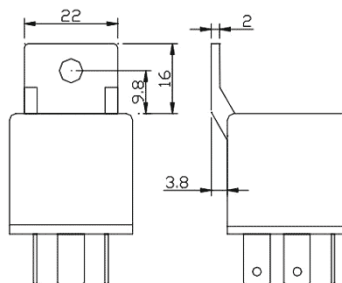
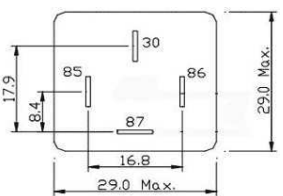
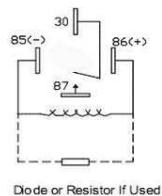

koda UNO	koda proizvajalca	napetost tuljave	št. polov	nosilnost kontaktov	pakiranje
E4/7632B	FRC3A 12VDC	12 VDC	1	70A/14VDC	1
E4/7633B	FRC3A 24VDC	24 VDC	1	70A/14VDC	1

3 polni undecal rele

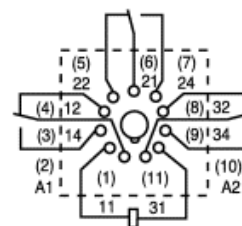
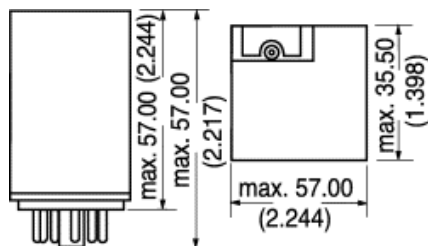

koda UNO	koda proizvajalca	napetost tuljave	št. polov	nosilnost kontaktov	pakiranje
E4/7646	MT321024 SCHRACK	24 VDC	3	10A/230VAC	1

V IZDELAVI

PODNOŽJA ZA RELEJE

Podnožje za 1 polne in 2 polne releje.



E22/2400

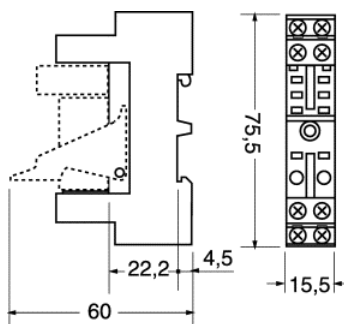

E22/2410

koda UNO	koda proizvajalca	pakiranje	opis artikla
E22/2400	GOODSKY PI-50BE	20	podnožje vijčno, za na DIN letev, za 1 in 2 polne releje, nosilnost po kontaktu 12A/300VAC, črne barve
E22/2410	GOODSKY 6.73.00.62.3	1	vzmet iz umetne mase

Podnožje za 4 polne releje.



E22/4400
bele barve
z vzmetjo

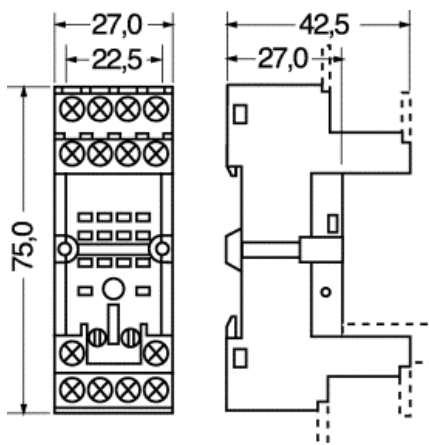

E22/4400Č
črne barve



E22/2420
6-24VDC



E22/2424
110-230VAC

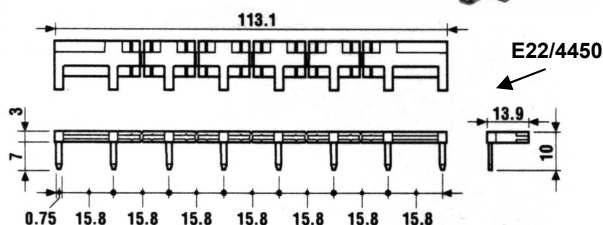

koda UNO	koda proizvajalca	opis artikla
E22/4400	C. GAVAZZI ZMI4NA	podnožje vijčno, za na DIN letev, za 2 in 4 polne releje serije RMI, nosilnost po kontaktu 12A/300VAC, + plastično vzmet, bele barve
E22/4400Č	GOODSKY PYF-14BE	podnožje vijčno, za na DIN letev, za 2 in 4 polne releje serije RMI, nosilnost po kontaktu 12A/300VAC, črne barve
E22/4410	C. GAVAZZI MS 35B/1	vzmet iz umetne mase
E22/2420	LM-CF-G	signalno zaščitni modul 6-24VDC z zeleno led diodo in zaščitno diodo 1N4007
E22/2424	LM-EN	signalni modul z rdečo led diodo za napetosti od 110 do 230VAC
E22/4450	FINDER 095.08	mostična letev 8 polna, za vsa podnožja relejev. Raster med kontakti je 15,8mm.

ČASOVNI RELE MULTIFUNKCIJSKI

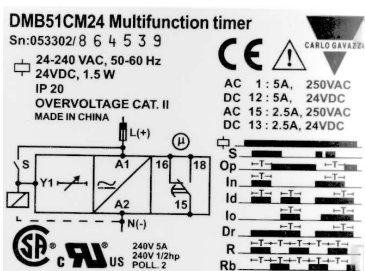

Časovni rele multifunkcijski, multinapetostni z 7 funkcijami in 7 časovnimi območji.

- Nastavljivi čas od 0,1s do 100h
- 7 nastavljenih funkcij
- Avtomatski ali ročni štart
- 1 preklopni kontakt 8A 250VAC
- Napajanje 24VDC, ali 24 do 240VAC
- Montaža na DIN letev
- Dve LED diodi za prikazovanje statusa izhoda in napajanja

- Časovna območja:
- 0,1 do 1s
 - 1 do 10s
 - 6 do 60s
 - 60 do 600s
 - 0,1 do 1h
 - 1 do 10h
 - 10 do 100h
- Časovno odstopanje: < 5%
- Ponovljivost: > 0,2%
- Krmilna napetost: 24VDC ali 24 do 240VAC 1,5W
- Preklopni kontakt: 8A 250VAC
- 7 nastavljenih funkcij:
- Op zakasnitev pri vzburjanju
 - In interval pri vzburjanju
 - Io interval po vzburjanju
 - Id dvojni interval
 - Dr zakasnitev po vzburjanju
 - R someren cikel (štart pri ON)
 - Rb someren cikel (štart pri OFF)

koda UNO	koda	krmilna napetost	št. polov	nosilnost kontaktov	pakiranje
E22/5000	Gavazzi DMB51CM24	24 VDC, 24 - 240VAC	1	8A/250 VAC	1
E22/5001	Lovato TM M1	12 - 240VAC/DC	1	8A/250 VAC	1

RELE SOLID STATE

Rele solid state, AC in DC preklop .
Enofazni, zero switching z LED indikacijo stanja.



koda UNO	koda C. GAVAZZI	krmilna napetost	št. polov	nosilnost na izhodu	pakiranje
E22/6000	RS1A40D40	4 - 32VDC	1	40A/400 Vrms	1
E22/6010	RM1A40D50	4 - 32VDC	1	50A/400 Vrms	1
E22/6011	RM1A60D100	3 - 32VDC	1	100A/600Vrms	1
E22/6012	RS1A40A2-40	230VAC	1	40A/400 Vrms	1
E22/6014		4 - 32VDC	1	40A/100VDC	1
E22/6032	RM1A40A50	22 - 48VDC, 20 - 280VAC	1	50A/400Vrms	1

UNO elektronika d.o.o.

Dolenja vas 1b
6224 Senožeče

tel. 05 76-56-140
fax. 05 76-56-141
www.unoelektronika.si
e-mail: uno.elektronika@siol.net

Po naročilu so dobavljivi tudi drugi artikli CARLO GAVAZZI, ki niso prisotni v tem katalogu!!
Podrobni opis artiklov s karakteristikami dobite na www.carlogavazzi.com

INDUKTIVNI SENZORJI - BREZKONTAKTNA STIKALA

Induktivni senzor M12, 3 žile DC.

V kovinskem ohišju, z vgrajeno LED diodo za kontrolo stanja.



E20/1100

E20/1102

Delovna napetost: 10 - 40VDC
Padec napetosti: < 2,5VDC
IP zaščita: IP67
Zaščita: proti kratkemu stiku in zamenjave polov
maksimalni tok: < 200mA pri 25°C
Delovna temperatura: -25°C do +70°C
Barva LED diode: rumena
Ohišje: cromirani baker in PVC
Homologacija: CE, UL, CSA



E20/1200
E20/1202

koda UNO	koda C. GAVAZZI	dimenzije	tip	hod navoja	delovna frekvenca	preklopna razdalja	priklop	pak
E20/1100	IA12DSF02PO	M12x41	PNP-NO	M12x1x30	2 KHz	2 mm	kabel 2 m	1
E20/1102	IA12DSN04PO	M12x45	PNP-NO	M12x1x30	2 KHz	4 mm	kabel 2 m	1
E20/1200	IA12ASF02POM1	M12x55,2	PNP-NO	M12x1x30	2 KHz	2 mm	4p. vtikač	1
E20/1202	IA12ASF02PCM1	M12x55,2	PNP-NC	M12x1x30	2 KHz	2 mm	4p. vtikač	1

Induktivni senzor M18, 3 žile DC.

V kovinskem ohišju, z vgrajeno LED diodo za kontrolo stanja.



E20/1300
E20/1302

E20/1400

Delovna napetost: 10 - 40VDC
Padec napetosti: < 2,5VDC
IP zaščita: IP67
Zaščita: proti kratkemu stiku in zamenjave polov
maksimalni tok: < 200mA pri 25°C
Delovna temperatura: -25°C do +70°C
Barva LED diode: rumena
Ohišje: cromirani baker in PVC
Homologacija: CE, UL, CSA

koda UNO	koda C. GAVAZZI	dimenzije	tip	hod navoja	delovna frekvenca	preklopna razdalja	priklop	pak
E20/1300	IA18DSF05PO	M18x41,6	PNP-NO	M18x1x30	1,5 KHz	5 mm	kabel 2 m	1
E20/1302	IA18DSN08PO	M18x49,6	PNP-NO	M18x1x30	1,5 KHz	8 mm	kabel 2 m	1
E20/1400	IA18ASF05POM1	M18x55	PNP-NO	M18x1x30	1,5 KHz	5 mm	4p. vtikač	1

Induktivni senzor M30, 3 žile DC.

V kovinskem ohišju, z vgrajeno LED diodo za kontrolo stanja.



E20/1500

Delovna napetost: 10 - 40VDC
Padec napetosti: < 2,5VDC
IP zaščita: IP67
Zaščita: proti kratkemu stiku in zamenjave polov
maksimalni tok: < 200mA pri 25°C
Delovna temperatura: -25°C do +70°C
Barva LED diode: rumena
Ohišje: cromirani baker in PVC
Homologacija: CE, UL, CSA

koda UNO	koda C. GAVAZZI	dimenzije	tip	hod navoja	delovna frekvenca	preklopna razdalja	priklop	pak
E20/1500	IA30DSF15PO	M30x43,6	PNP-NO	M30x1,5x30	700 Hz	15 mm	kabel 2 m	1

POVEZOVALNI KABLI IN KONEKTORJI ZA INDUKTIVNA STIKALA

Povezovalni kabel s konektorjem pod kotom, za induktivne senzorje.

Konektor je v kovinski izvedbi z vodilom za kabel, zaščita IP68. Primeren za 2, 3 ali 4 pinske senzorje DC.



koda UNO	koda C. GAVAZZI	konektor	kabel	dolžina kabla	pakiranje
E20/1900	CONG10-A2	vtičnica M12 4 polna po kotom (90°)	3 žilni	2m	1
E20/1902	CONG10-A5	vtičnica M12 4 polna po kotom (90°)	3 žilni	5m	1
E20/1804	CONG1A-A5	vtičnica M12 4 polna po kotom (90°)	4 žilni	5m	1

Povezovalni konektor, za induktivne senzorje

Konektor je v kovinski izvedbi z vodilom za kabel, zaščita IP68. Kontakti na vijak.



koda UNO	koda C. GAVAZZI	konektor	za kabel	pakiranje
E20/1920	CONM14NF-S	vtičnica M12 4 polna	2, 3 ali 4 žilni	1
E20/1922	CONM14NF-A	vtičnica M12 4 polna po kotom (90°)	2, 3 ali 4 žilni	1



UNO elektronika d.o.o.

Dolenja vas 1b
6224 Senožeče

tel. 05 76-56-140

fax. 05 76-56-141

www.unoelektronika.si

e-mail: uno.elektronika@siol.net

Po naročilu so dobavljivi tudi drugi artikli CARLO GAVAZZI, ki niso prisotni v tem katalogu!!

Podrobni opis artiklov s karakteristikami dobite na www.carlogavazzi.com

DIODE



DO41

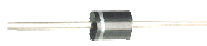

DO201

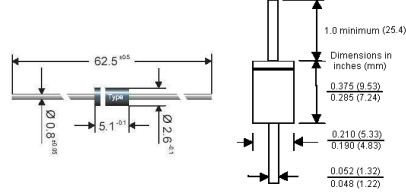

koda	model	tok	napetost	ohišje	pakiranje
E60/7105	1N4007	1A	1000V	DO41	10
E60/8065	1N5408	3A	1000V	DO201	10
E60/8066B	BY500-800	5A	500V	DO201	10

MOČNOSTNE DIODE



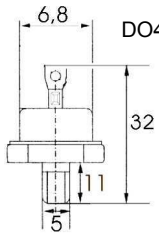

DO4

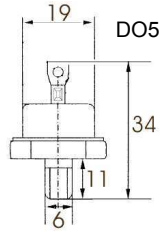

DO5



Katoda Anoda

koda	model	nominalni tok	napetost	ohišje	polariteta	pakiranje	v kompletu
E60/9100	25F100	25A	1000V	DO4	katoda na ohišju	1	matica+podložka
E60/9110	25FR100	25A	1000V	DO4	anoda na ohišju	1	matica+podložka
E60/9200	40HF120	40A	1200V	DO5	katoda na ohišju	1	matica+podložka
E60/9210	40HFR100	40A	1000V	DO5	anoda na ohišju	1	matica+podložka

MOČNOSTNE DIODE

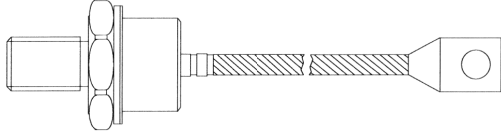

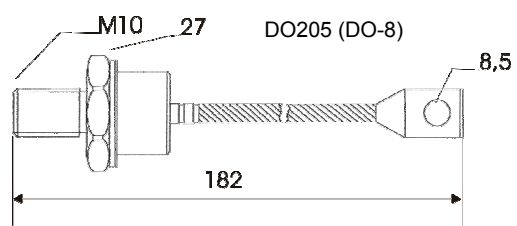

DO205 (DO-8)

Koda	model	nominalni tok	napetost	ohišje	polariteta	pakiranje	v kompletu
E60/9300	150U80D	150A	800V	DO-205	katoda na ohišju	1	matica+podložka
E60/9310	150UR80D	150A	800V	DO-205	anoda na ohišju	1	matica+podložka

MOST GREATZ



koda	model	tok	napetost	pakiranje
E64/665	FB1	8A	1000V	1

MOST GREATZ 3 FAZNI

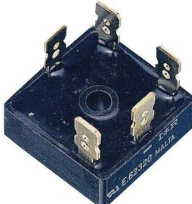

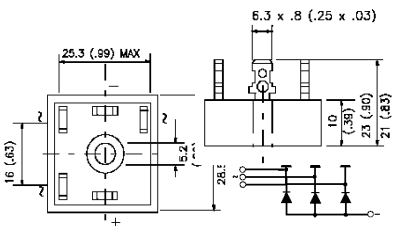

koda	model	tok	napetost	pakiranje
E64/1553	26MT80	25A	800V	1

MOST GREATZ

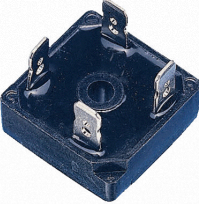

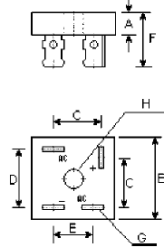

DIM	mm
A	11
B	28,5
C	17
D	18
E	15
F	25,4
H	4,9

koda	model	tok	napetost	pakiranje
E64/1510	KBPC3506	25A	600V	1
E64/1532	KBPC3506	35A	600V	1

UNO elektronika d.o.o.

Dolenja vas 1b
6224 Senožeče

www.unoelektronika.si
e-mail: uno.elektronika@siol.net

POTENCIOMETER LINEARNI 0,25W

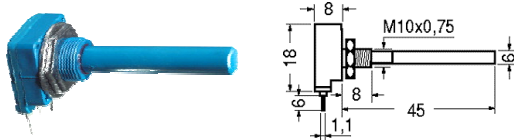

koda	vrednost	pakiranje
E2/1058	1 Kohm	1
E2/1059	2,2 Kohm	1
E2/1060	4,7 Kohm	1
E2/1062	10 Kohm	1
E2/1063	22 Kohm	1
E2/1064	47 Kohm	1
E2/1066	100 Kohm	1
E2/1067	220 Kohm	1
E2/1068	470 Kohm	1

POTENCIOMETER ŽIČNI 5W

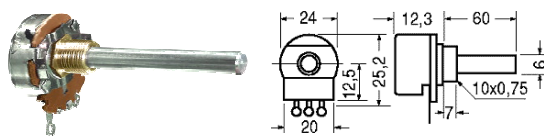

koda	vrednost	pakiranje
E2/7068	100 ohm	1
E2/7070	1 Kohm	1

POTENCIOMETER 10 OBRATOV 2W

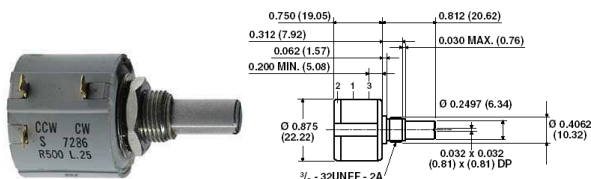

koda	vrednost	pakiranje
E2/31025	5 Kohm	1
E2/31030	10 Kohm	1
E2/31045	100 Kohm	1

GUMB ZA POTENCIOMETER 10 OBRATOV, MIKROMETRIČNO ODCITAVANJE fi 22mm

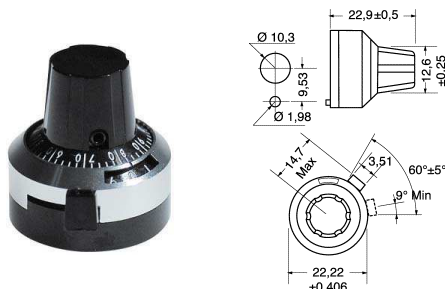

koda	fi zunanji	fi osovine potenciometra	pak.
C15/9050	22mm	6,34mm	1

GUMB ZA POTENCIOMETER fi 22mm



koda	fi zunanji	fi osovine potenciometra	pak.
C15/7050A	22mm	6mm	1

OŠTEVILČEN DISK ZA GUMB fi 22mm, OD 0 DO 10



koda	fi zunanji D	fi notranji d	pakiranje
C15/7762	36mm	16,5mm	1

KAZALEC ZA GUMB fi 22mm

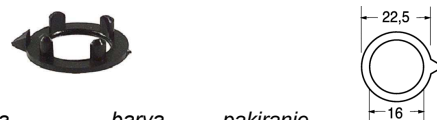

Koda	barva	pakiranje
C15/7620	črna	1
C15/7630	modra	1

GUMB ZA POTENCIOMETER fi 15mm



koda	fi zunanji	fi osovine potenciometra	pak.
C15/7000A	15mm	6mm	1

KAZALEC ZA GUMB fi 15mm



Koda	barva	pakiranje
C15/7600	črna	1

V IZDELAVI

BATERIJSKA SVETILKA PRENOSNA, AKUMULATORSKA, ZASILNA,



koda pak.
BSTT1600 1



Baterijska svetilka prenosna, akumulatorska, zasilna, fluo cev 9W

Akumulatorska baterijska svetilka se samodejno prižge v primeru izpada omrežne napetosti.

SPLOŠNI PODATKI:

baterija: svinčena 6V 4,5Ah, brez vzdrževanja

napajanje: 230V z zaščito proti prepolnjenju

žarnica : fluorescentna PL 9W

Čas polnenja : 20 – 24h

zmogljivost : sveti približno 4h

dimenzije: 180x100x50mm

Garancija 12 mesecev.

BATERIJSKA SVETILKA Z 3 LED DIODAMI Z ROČNIM POLNENJEM



koda pak.
BSTT2004 1



Baterijska svetilka ročna z 3 LED diodami

LED baterijska svetilka za delovanje ne potrebuje baterij! Polnimo jo z tresenjem 30 do 60 sekund, kar zadostuje za delovanje 12 do 30 minut!

Z tresenjem premikamo zmogljiv magnet ki polni notranji akumulator.

Če uporabimo eno samo LED diodo, ta sveti do 30 minut, če uporabimo 3 LED diode pa do 12 minut.

Baterijska svetilka je trpežne izvedbe, vodotesna in plovna!

SPLOŠNI PODATKI:

svetilno telo: 3 LED diode visoke svetilnosti bele barve

ohišje: iz ABS

dimenzije: 220x48mm

svetilnost: 45000mcd

zmogljivost: sveti do 30 min. z eno LED

diodo ali 12 min z 3 LED diodami **Je**

primeren za napajanje hladilnikov!

Garancija 12 mesecev.

V IZDELAVI