

Power PCB Relay RT1 Inrush Power

- 1 pole 16A, 1 form A (NO) contact (W pre-make contact + AgSnO₂)
- 165A/20ms inrush peak current
- Mono- or bistable coil
- 5kV/10mm coil-contact
- Reinforced insulation
- Test tab (manual operator) optional
- WG version: product in accordance to IEC60335-1

Typical applications

Lighting systems, movement sensors, filament and incandescent lamp loads, motors.



Approvals

VDE Cert. No. 40007571, UL E214025, cCSAus 1142018
Technical data of approved types on request.

Contact Data	RT.3T	RTS3L
Contact arrangement	1 form A (NO) contact	
Rated voltage	250VAC	
Max. switching voltage	400VAC	
Rated current	16A	
Limiting continuous current	16A, UL: 20A (RTS3L)	
Limiting making current, max. 20ms (incand. lamps)	165A	120A
Breaking capacity max.	4000VA	
Contact material	W (pre-make cont.) +AgSnO ₂	AgSnO ₂
Contact style	pre-make contact	single contact
Frequency of operation, with/without load	360/3600h ⁻¹	
Operate/release time max., DC coil	10/5ms	
Operate/Reset time max., bistable version	10/10ms	
Bounce time max.	4ms	

Contact ratings

Type	Contact	Load	Cycles
IEC 61810			
RTS3L	A (NO)	20A, 250VAC resistive, 70°C	20x10 ³
RTS3L monostable A (NO)	16A, 250VAC resistive, 85°C		100x10 ³
RTS3T	A (NO)	16A, 250VAC resistive, 85°C	5x10³
UL 508			
RTS3L	A (NO)	20A, 250VAC, general purpose, 70°C	20x10 ³
RTS3L	A (NO)	16A, 250VAC, resistive, 85°C	50x10 ³
RTS3L	A (NO)	TV8, 240VAC, 40°C	25x10 ³
RTS3L	A (NO)	1.5hp, 240VAC, 70°C	30x10 ³
RTS3T	A (NO)	1200W Tungsten, 120VAC/277VAC, 60Hz, 50°C	6x10³
RTS3T	A (NO)	620W Discharge lamps (standard ballast), 120VAC/277VAC, 60Hz, 50°C	6x10³

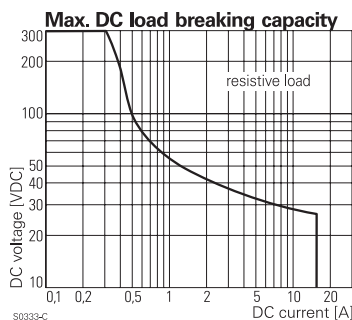

Contact Data (continued)

Mechanical endurance		
DC coil	>5x10 ⁶ ops.	>10x10 ⁶ ops.
bistable version	>3x10 ⁶ ops.	>5x10 ⁶ ops.
tab manually operated	>1x10 ³ ops.	-

Coil Data, monostable DC coil

Coil voltage range	5 to 110VDC
Operative range, IEC 61810	2
Coil insulation system according UL1446	class F

Coil versions, monostable DC coil

Coil code	Rated voltage VDC	Operate voltage VDC	Release voltage VDC	Coil resistance Ω±10% ¹⁾	Rated coil power mW
005	5	3.5	0.5	62	403
006	6	4.2	0.6	90	400
009	9	6.3	0.9	203	400
012	12	8.4	1.2	360	400
024	24	16.8	2.4	1440	400
048	48	33.6	4.8	5520	417
060	60	42.0	6.0	8570 ¹⁾	420
110	110	77.0	11.0	28800 ¹⁾	420

1) Coil resistance ±12%.

All figures are given for coil without pre-energization, at ambient temperature +23°C. Other coil voltages on request.

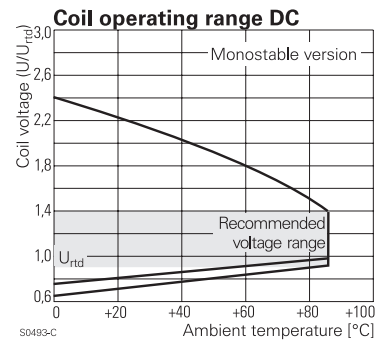

Coil Data, bistable coils

	1 coil	2 coils
Magnetic system	polarized, bistable	
Coil voltage range	3 to 24VDC	
Operative range, IEC 61810	2	
Limiting voltage, % of rated coil voltage	120%	150%
Min./Max. energization duration	30ms/1min at <10% duty factor	
Coil insulation system according UL1446	class F	

Power PCB Relay RT1 Inrush Power (Continued)

Coil Data (continued)

Coil versions, bistable

Coil code	Rated voltage VDC	Set voltage VDC	Reset voltage VDC	Coil resistance $\Omega \pm 10\%$	Rated coil power mW
A03	3	2.1	1.7	21	429
A12	12	8.4	6.6	360	400
A24	24	16.8	13.2	1440	400

Coil versions, bistable 1 coil

A03	3	2.1	1.7	21	429
A12	12	8.4	6.6	360	400
A24	24	16.8	13.2	1440	400

Coil versions, bistable 2 coils

F03	3	2.1	1.7	15	600
F12	12	8.4	6.6	240	600
F24	24	16.8	13.2	886	650

All figures are given for coil without pre-energization, at ambient temperature +23°C. Other coil voltages on request.

Bistable coils - operation

Version	1 coil		2 coils		
Coil terminals	A1	A2	A1	A3	A2
Operate	+	-	-	+	-
Reset	-	+	-	+	-

Contact position not defined at delivery

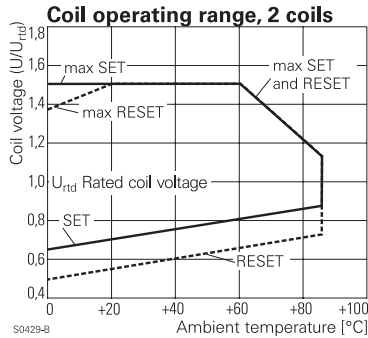
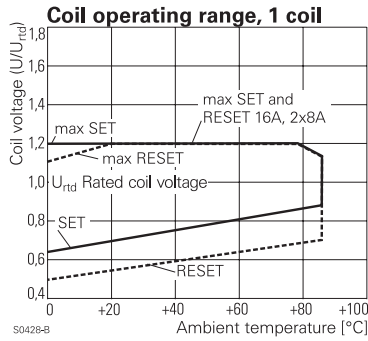

Insulation Data

Initial dielectric strength	
between open contacts	1250V _{rms}
between contact and coil	5000V _{rms}
Clearance/creepage	
between contact and coil	$\geq 10/10$ mm
Material group of insulation parts	IIIa
Tracking index of relay base	PTI 250V

Other Data

	RT.3T	RTS3L
Material compliance: EU RoHS/ELV, China RoHS, REACH, Halogen content refer to the Product Compliance Support Center at www.te.com/customer-support/rohssupportcenter		
Ambient temperature		
monostable DC coil		-40 to 85°C
bistable 1 coil		-10 to 85°C
bistable 2 coils		-40 to 85°C
Category of environmental protection		
IEC 61810		RTII - flux proof
Vibration resistance (functional), monostable version	10g	20g
Shock resistance (destructive)		100g
Terminal type	PCB-THT, plug-in ²⁾	
Weight, without / with test tab	14/16g	14g/-
Resistance to soldering heat THT		
IEC 60068-2-20	270°C/10s	
Packaging/unit		
without test tab	tube/20 pcs., box/500 pcs.	tube/20 pcs., box/500 pcs.
with test tab	tray/25 pcs., box/100 pcs.	- -

2) RTT3T or bistable 2 coil version: PCB mounting only. See Accessories.

Accessories RTS3.

For details see datasheet [Accessories Industrial Power Relay RT](#). Socket available for 1 coil version only. NOTE: indicated contact ratings and electrical endurance data for direct wiring of relays (according IEC 61810-1); for relays mounted on sockets deratings may apply.

Power PCB Relay RT1 Inrush Power (Continued)

Terminal assignment

Bottom view on solder pins

monostable version

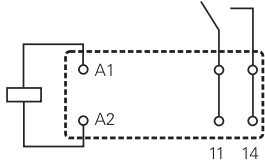

bistable version

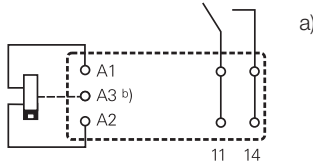

a) Indicated contact position during or after coil energization with reset voltage.

b) for 2 coil version only

Dimensions / PCB layout

version without test tab

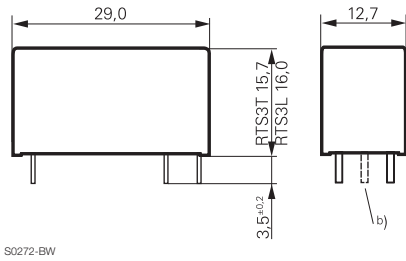

S0272-BW

16A, pinning 5mm

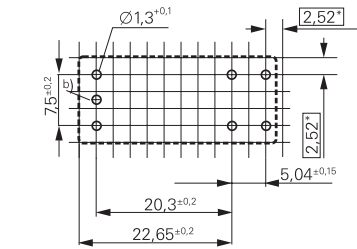

b) for 2 coil version only

version with test tab

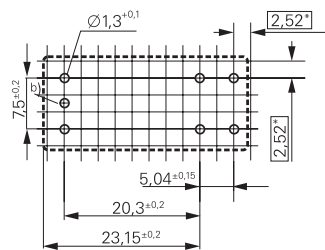
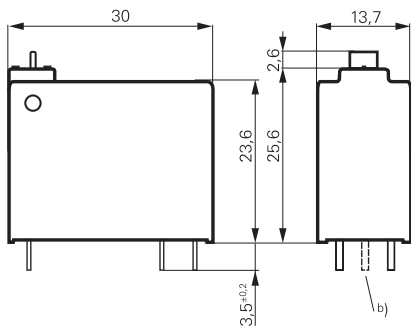
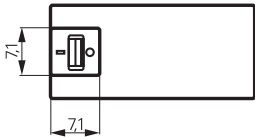

*) With the recommended PCB hole sizes a grid pattern from 2.5mm to 2.54mm can be used.

Power PCB Relay RT1 Inrush Power (Continued)

Product code structure		Typical product code				RT	S	3	T	A12
Type	RT	Power PCB Relay RT1 Inrush Power								
Version	S	Without test tab			T	With test tab (manual operator) for contact material, 'T' and bistable coil only				
Contact configuration	3	1 form A (NO) contact								
Contact material	L	AgSnO ₂		T	Tungsten (W) pre-make + AgSnO ₂					
Coil	Coil code: please refer to coil versions table									
Version	Blank	Standard Version								
	WG	Product in accordance to IEC 60335-1								

Product code	Version	Contacts	Contact material	Coil version	Coil	Version	Part number	
RTS3L005	Without test tab, 16mm high	1 form A (NO) contact	AgSnO ₂	Monostable	5VDC	Standard	1-1415898-8	
RTS3L006					6VDC		4-1415898-4	
RTS3L012	Without test tab, 15.7mm high		W pre-make + AgSnO ₂	Monostable	12VDC		1-1415898-9	
RTS3L024					24VDC		1-1415898-4	
RTS3LA12					Bistable, 1 coil		12VDC	2-1415898-3
RTS3LF12					Bistable, 2 coils			2-1415898-5
RTS3T005					5VDC		1-1415898-6	
RTS3T012					12VDC		1415898	
RTS3T024	24VDC	1415898-1						
RTS3T048	With test tab, 23.6mm high			Monostable	48VDC	IEC60335-1 compliant	1-1415898-1	
RTS3T060					60VDC		1-1415898-2	
RTS3TA05					Bistable, 1 coil		5VDC	1-1415898-5
RTS3TA06							6VDC	3-1415898-1
RTS3TA12							12VDC	1415898-2
RTS3TF03					Bistable, 2 coils		3VDC	1415898-4
RTS3TF12							12VDC	1415898-5
RTS3TF24							24VDC	1415898-6
RTT3TA12					Bistable, 1 coil		12VDC	1415898-7
RTT3TF24					Bistable, 2 coils		24VDC	1-1415898-0
RTS3L012WG	Without test tab, 15.7 mm high	1form A (NO) contact	AgSnO ₂	Monostable	12VDC		2-1415898-7	
RTS3L024WG					24VDC		5-1415898-1	
RTS3T012WG					12VDC		5-1415898-6	
RTS3TA24WG					Bistable 1 coil		24VDC	4-1415898-7

This list represents the most common types and does not show all variants covered by this datasheet.
Other types on request.